



CITY

60080



7 LEGO.com/city

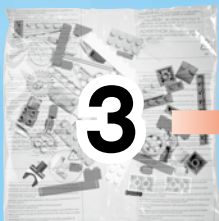
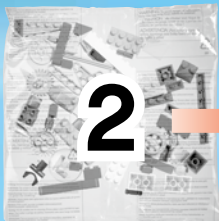

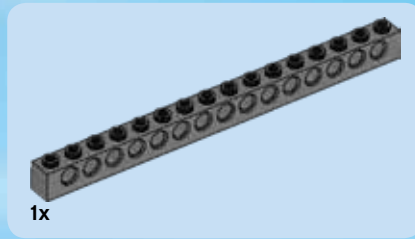
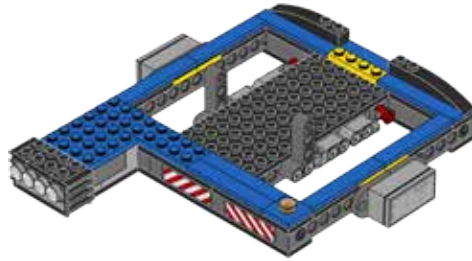
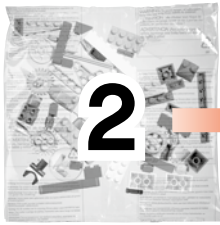

1

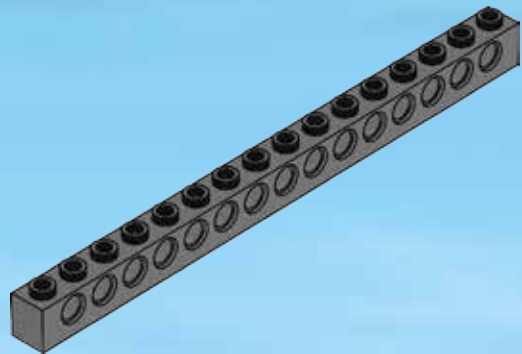



2x

2

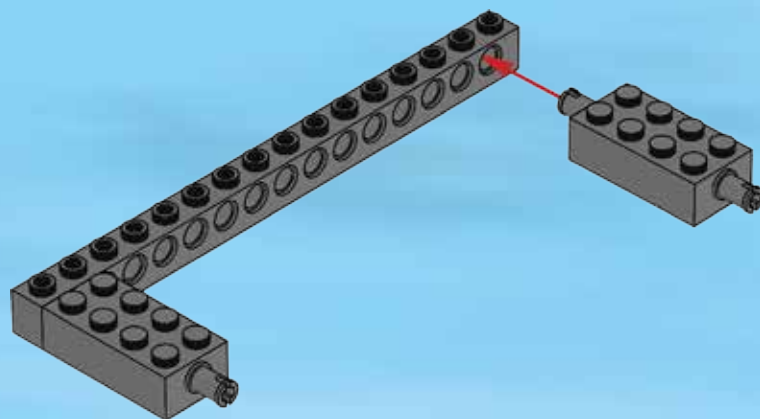

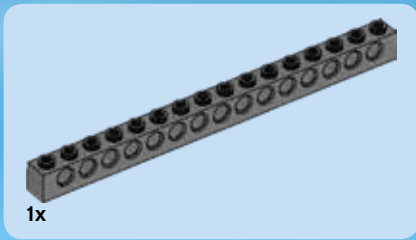

3

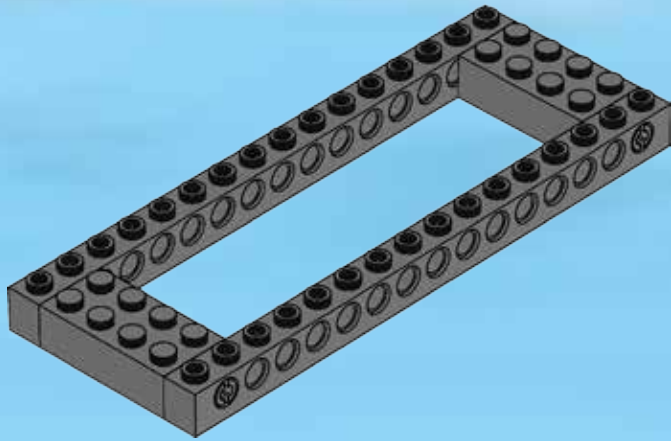

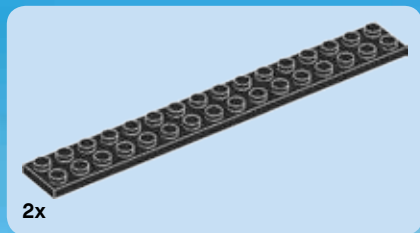

4

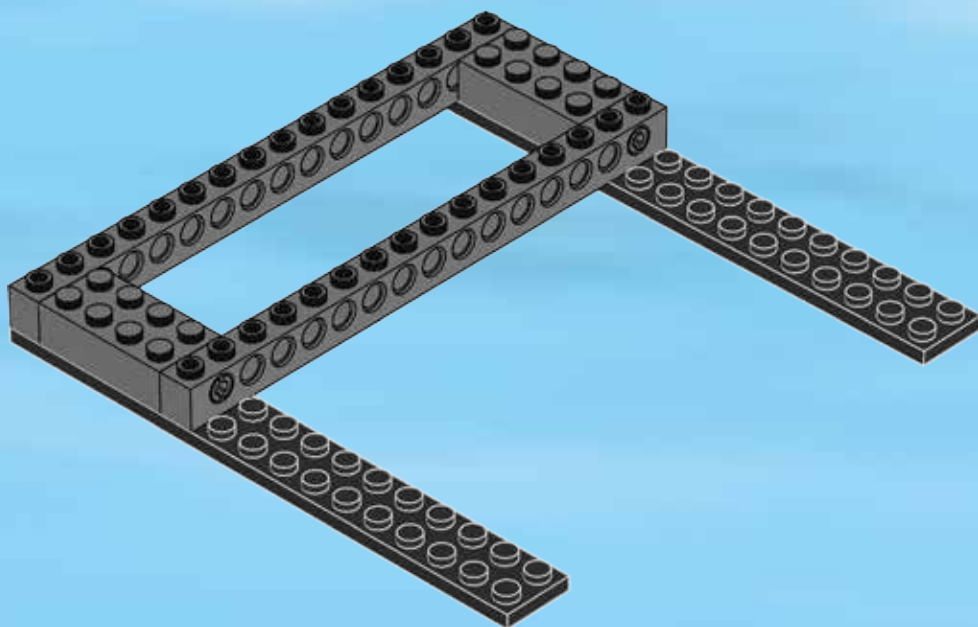



2x



2x

5

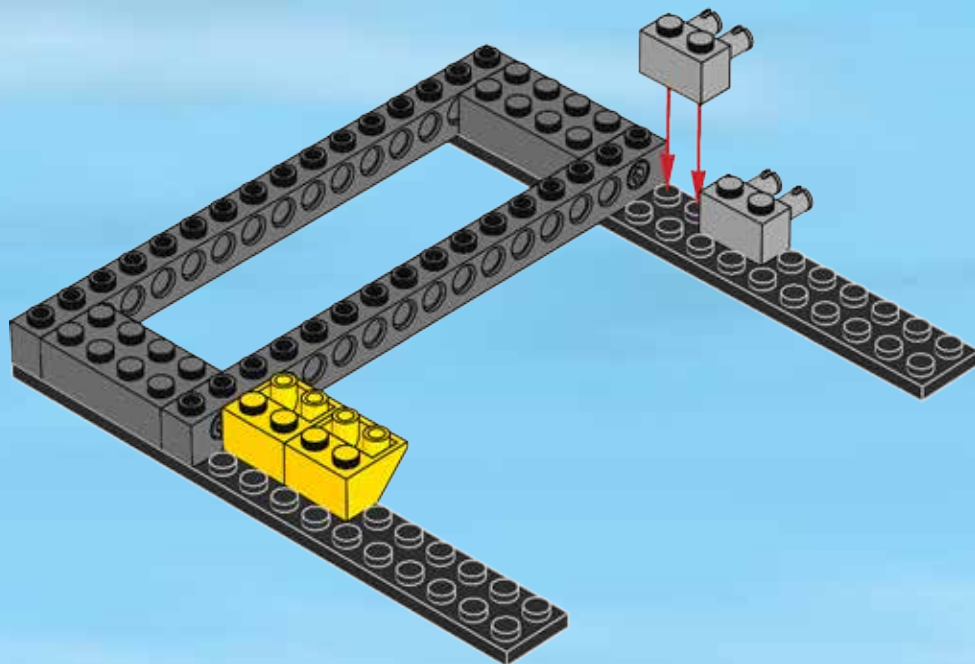



2x

6

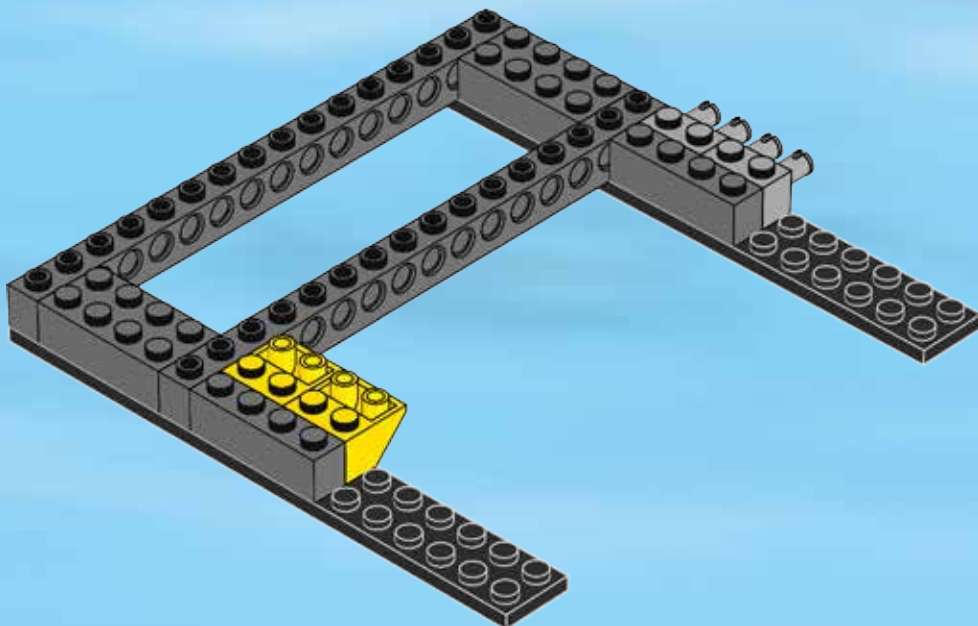

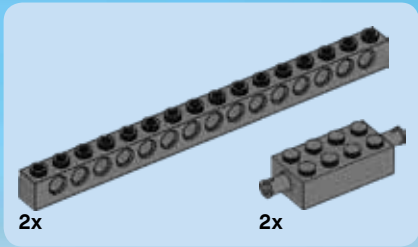
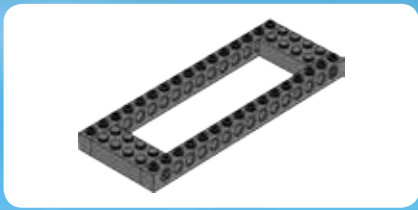

7

1

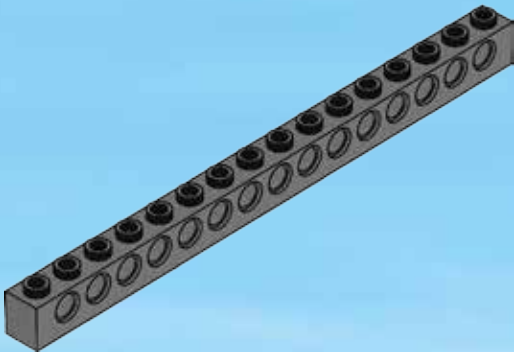

2

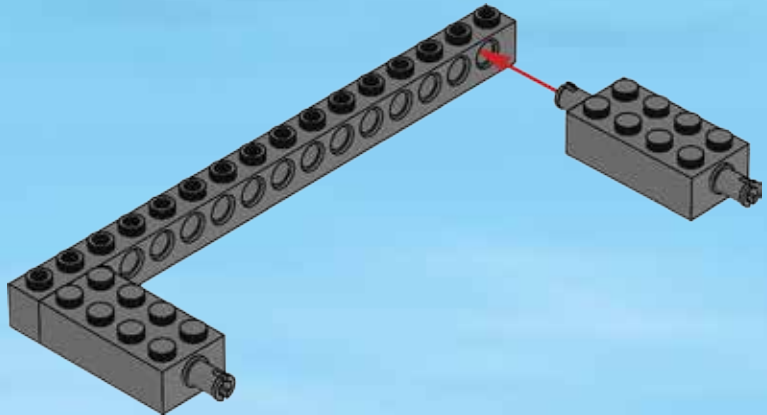

3

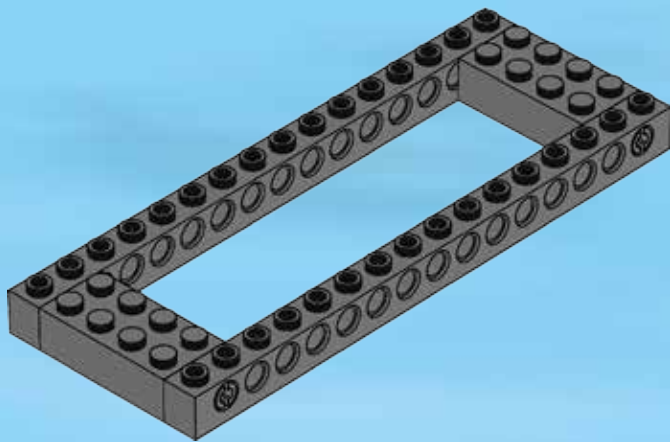

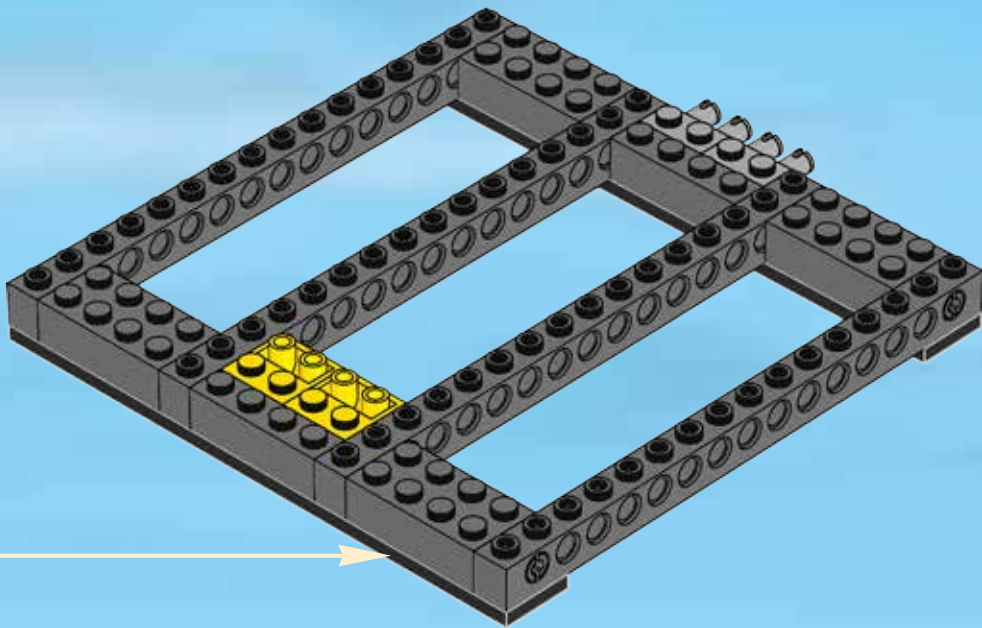

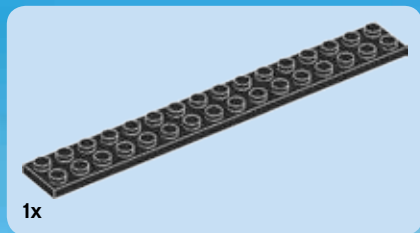

8

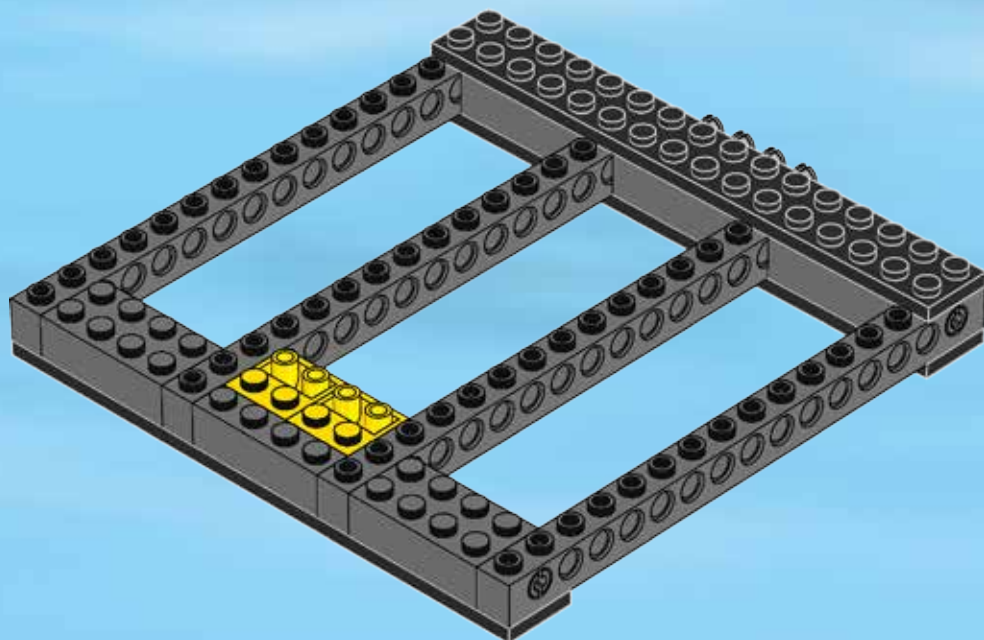



2x

9

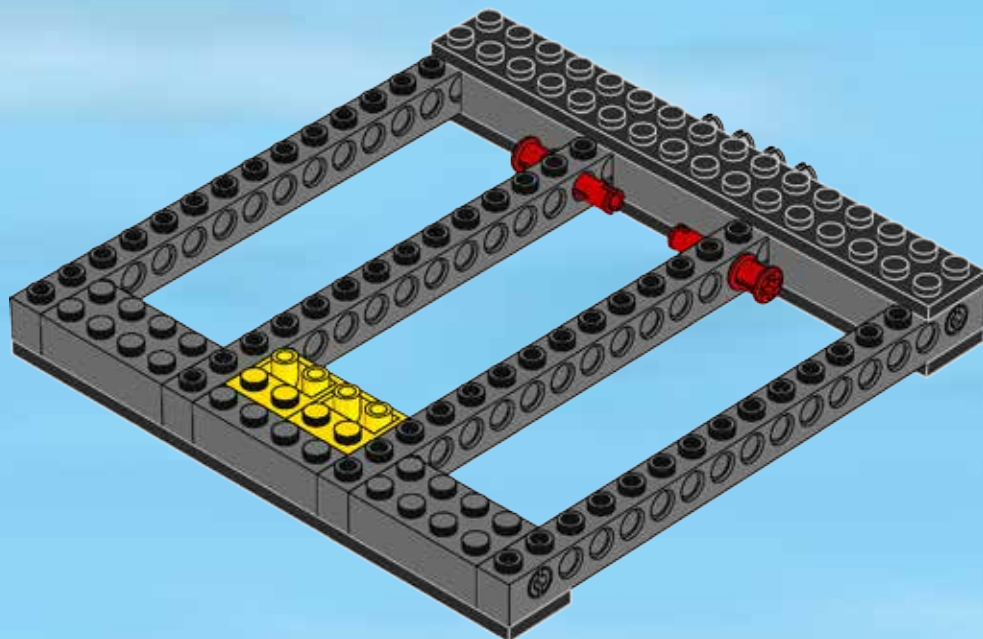

4x

2x

10

1

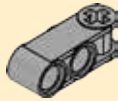

2

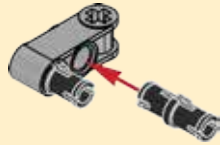

2x

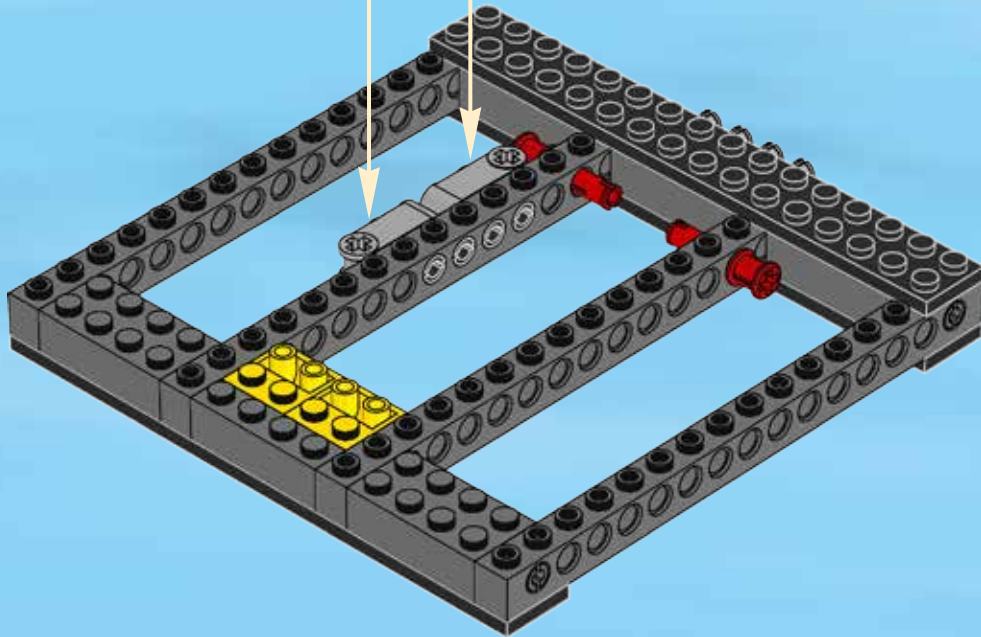

4x

2x

11

1



2

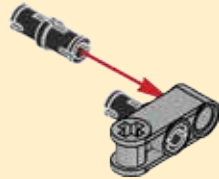

2x

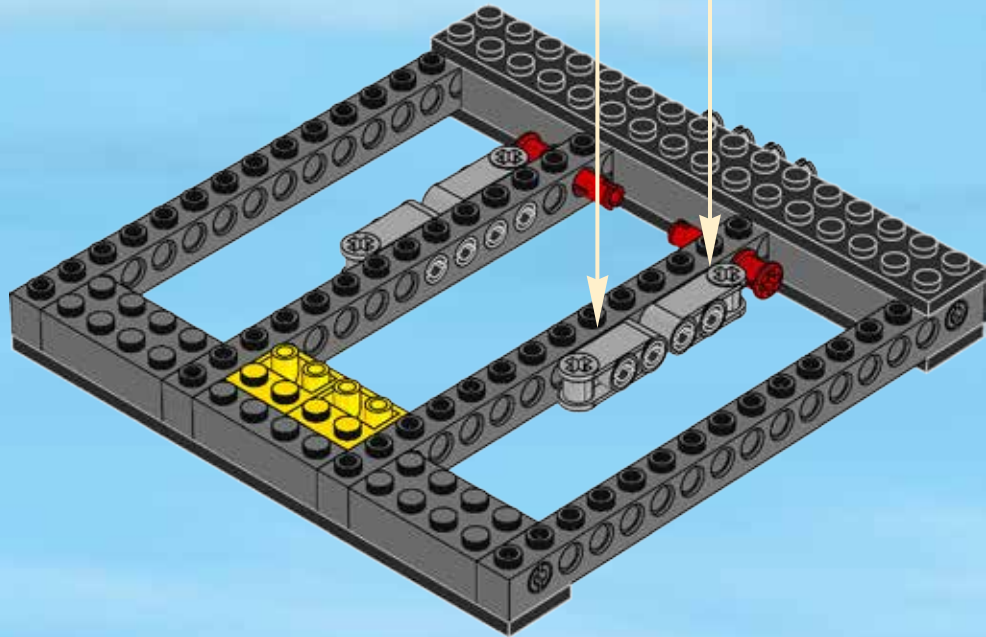

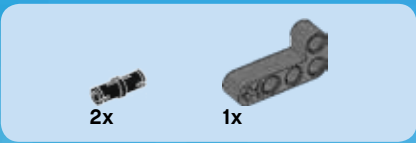

12

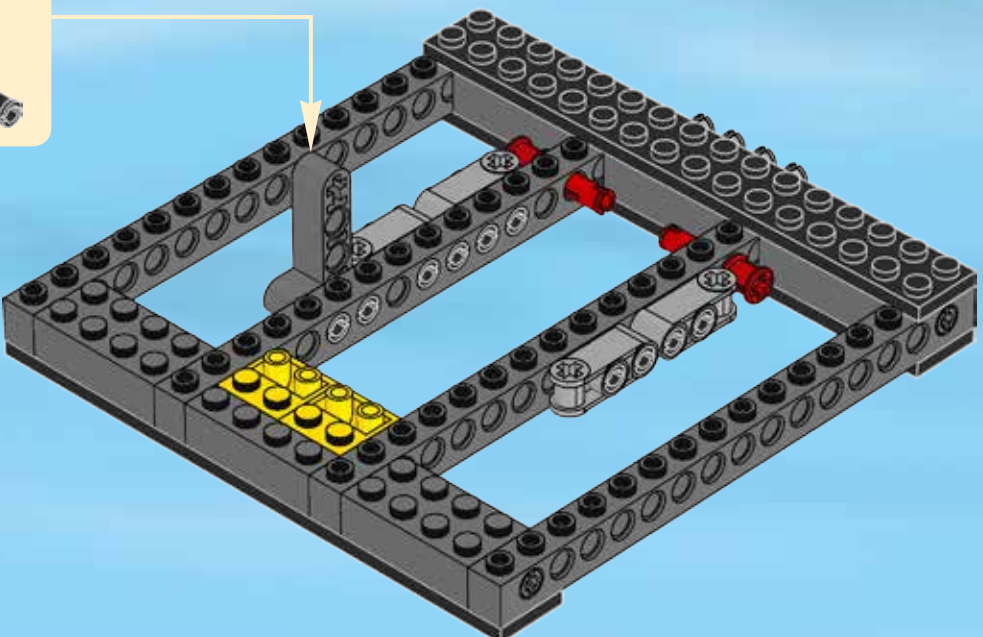
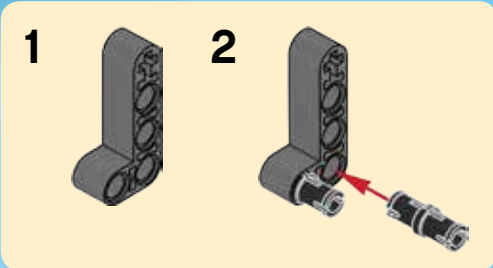



2x



1x

13

1

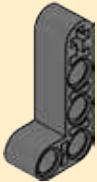

2

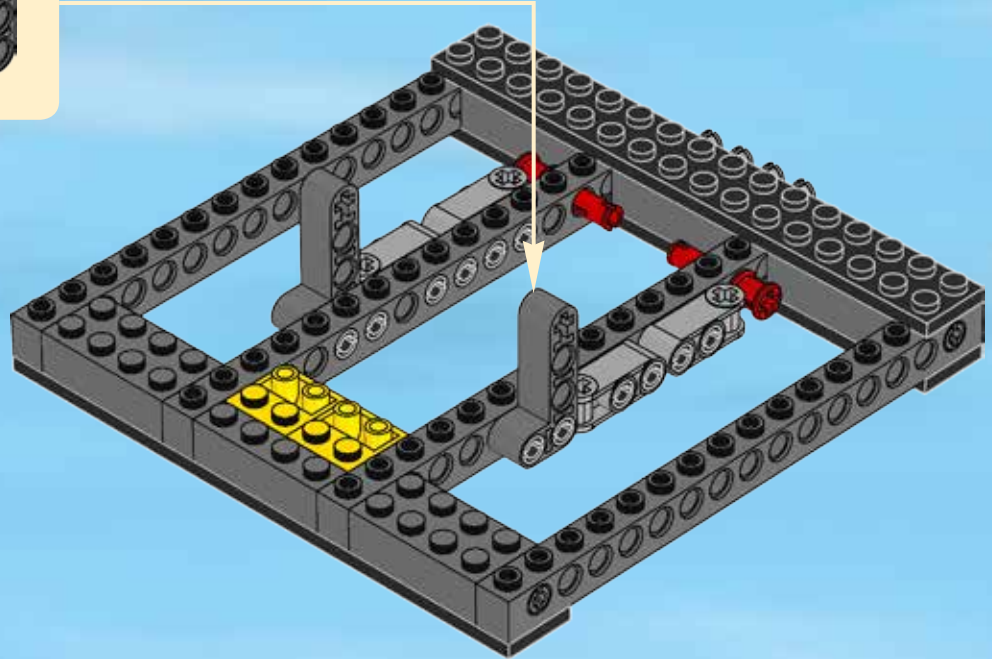
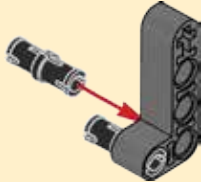

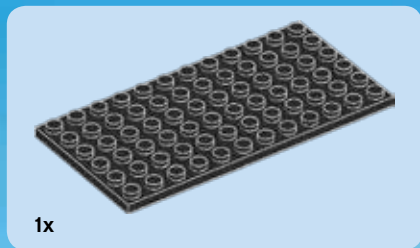

14

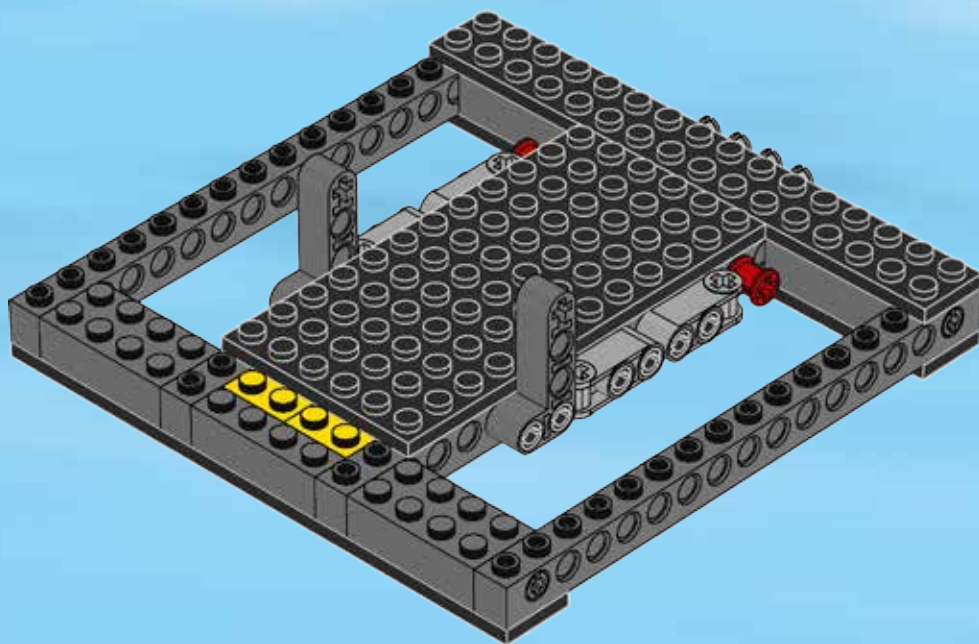



2x

15

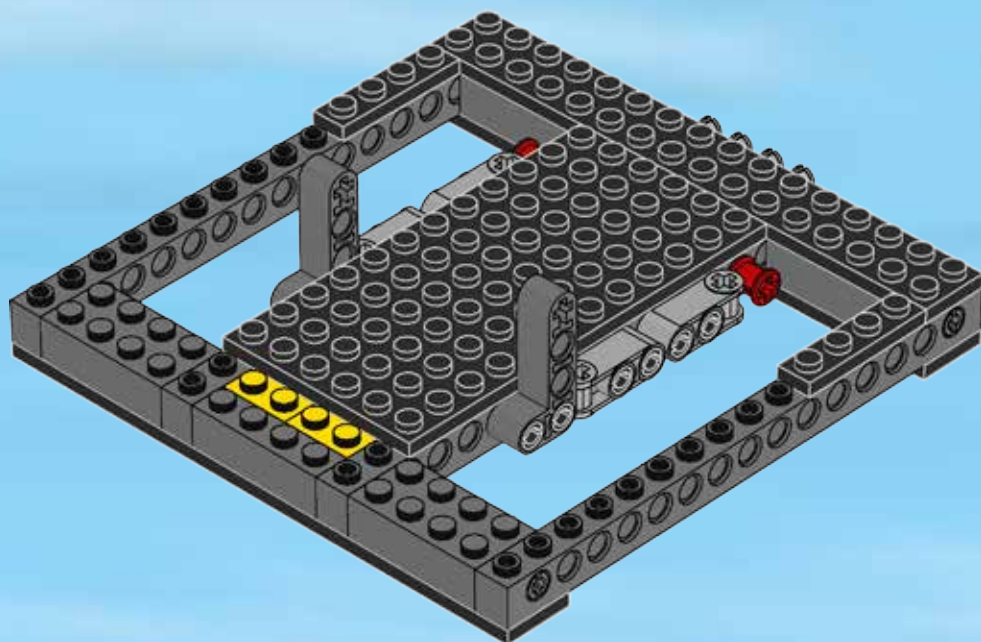



4x

16

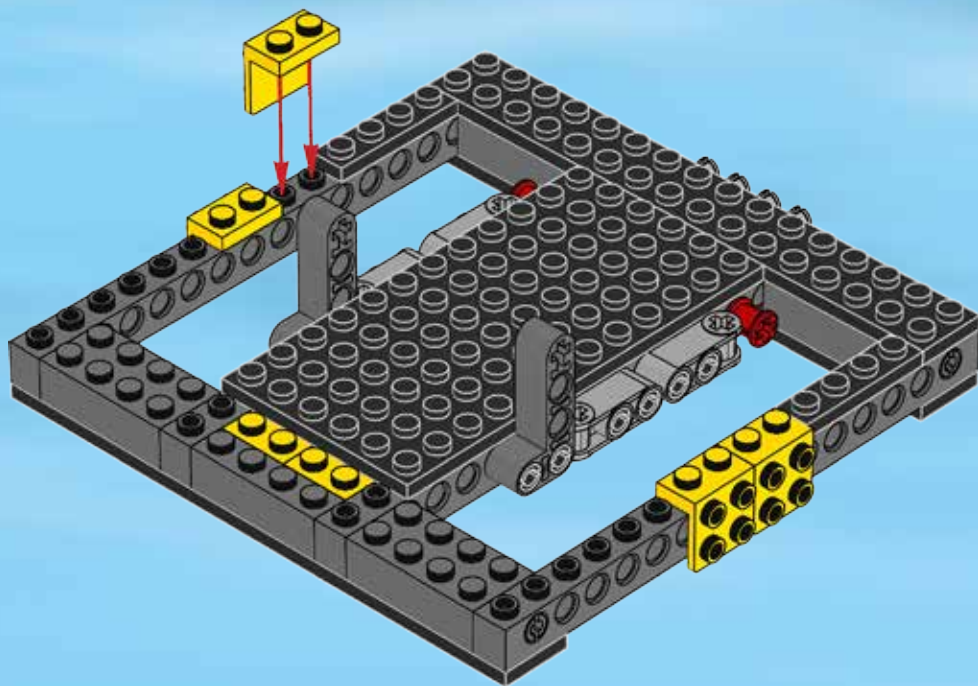



2x

17

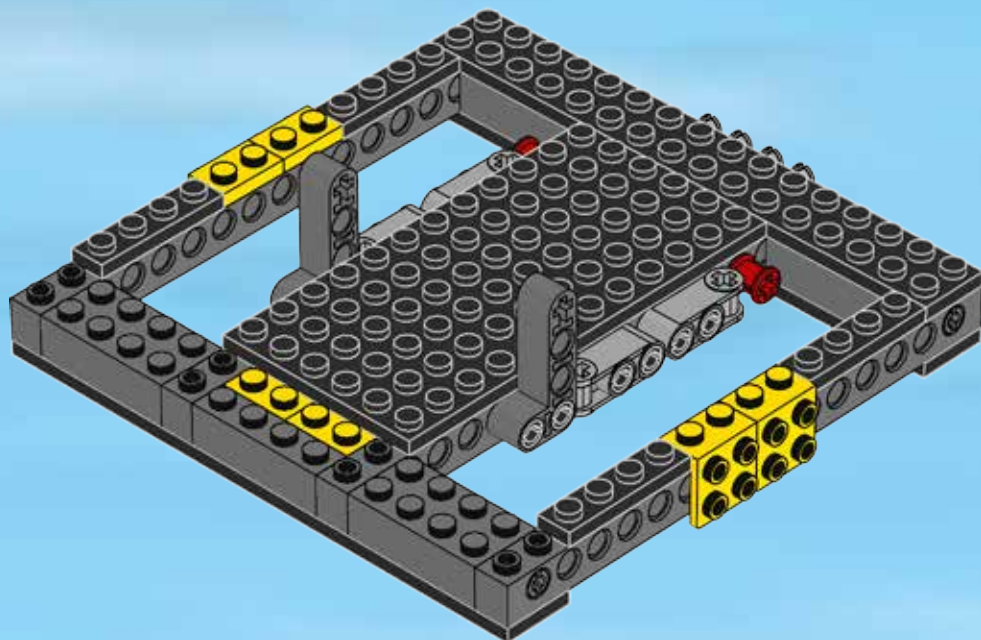

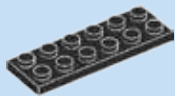

2x

18

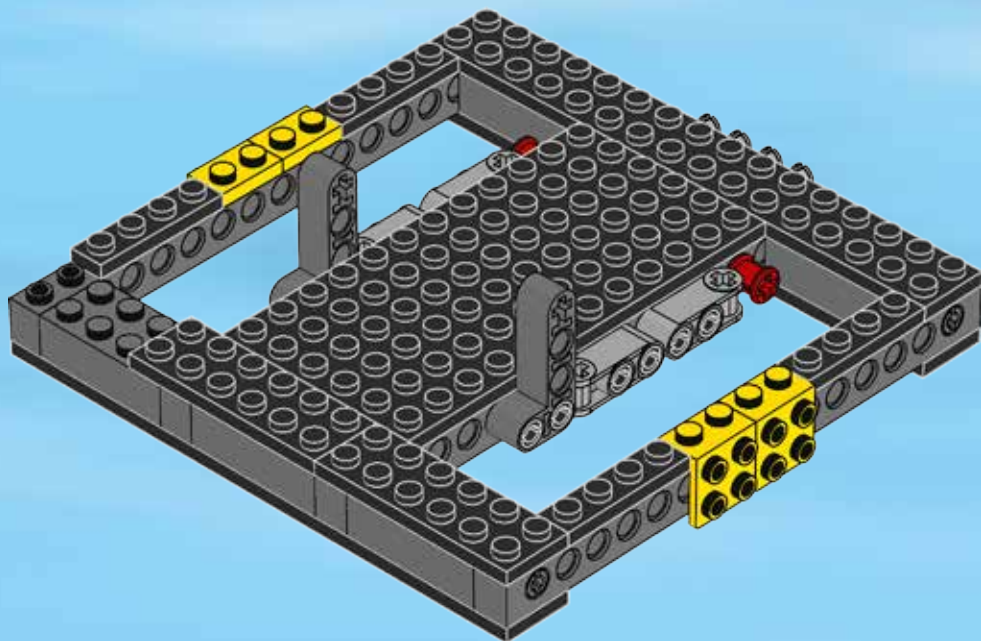



1x

1

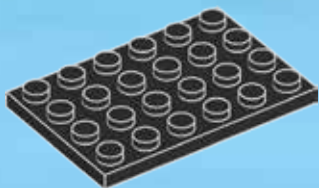

2x

2

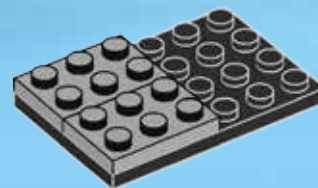

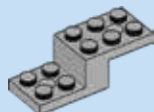

2x

3

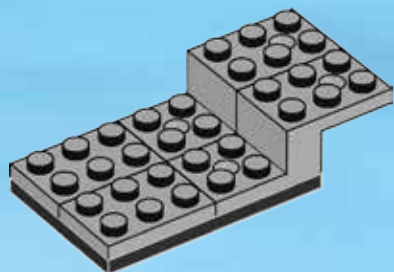

2x



1x

4

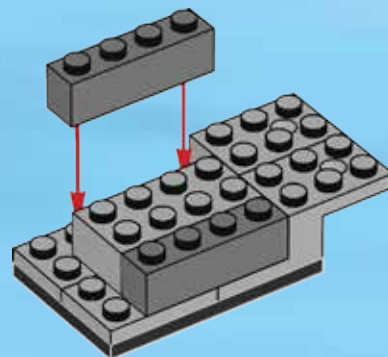

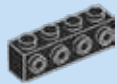

1x

5

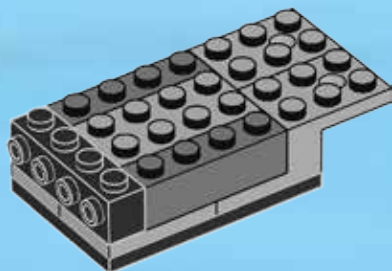

2x

6

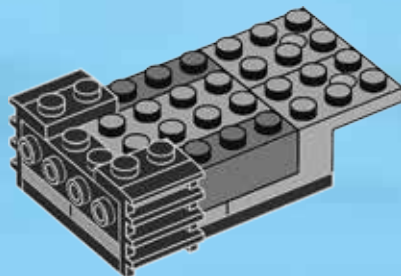



1x

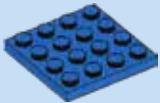

1x

7

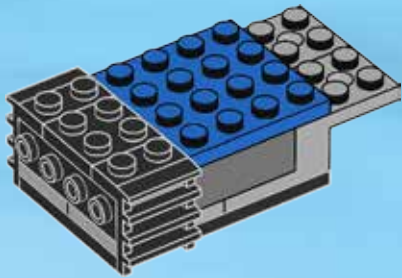

4x

8

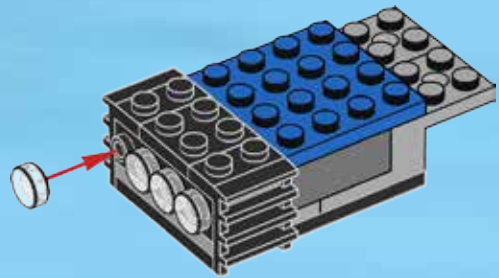

19

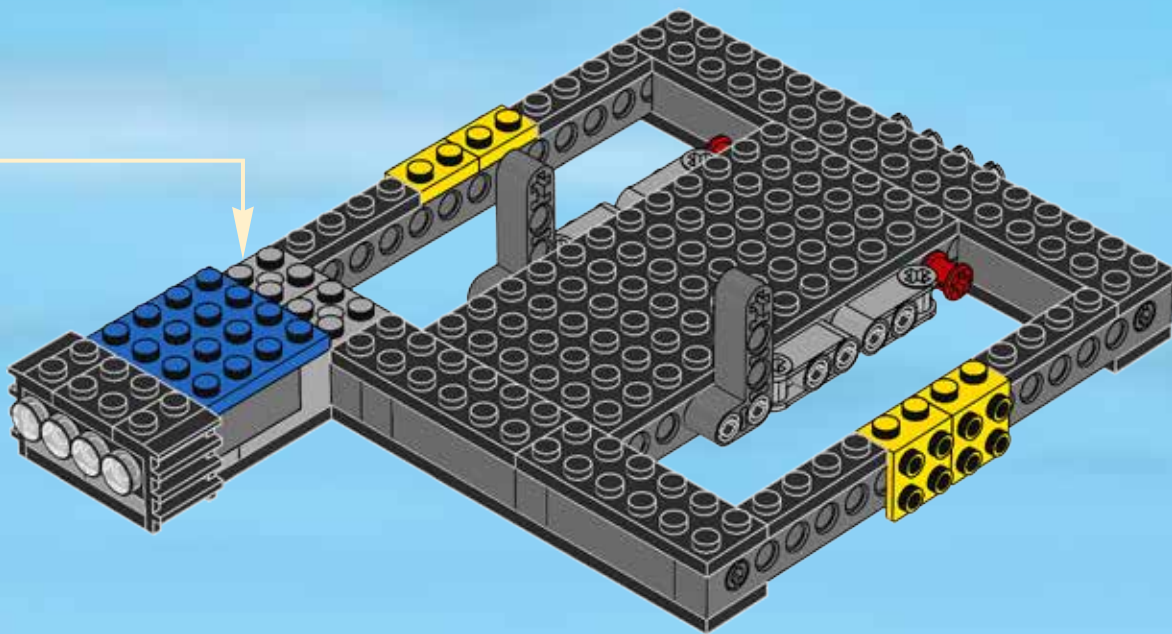



1x

20

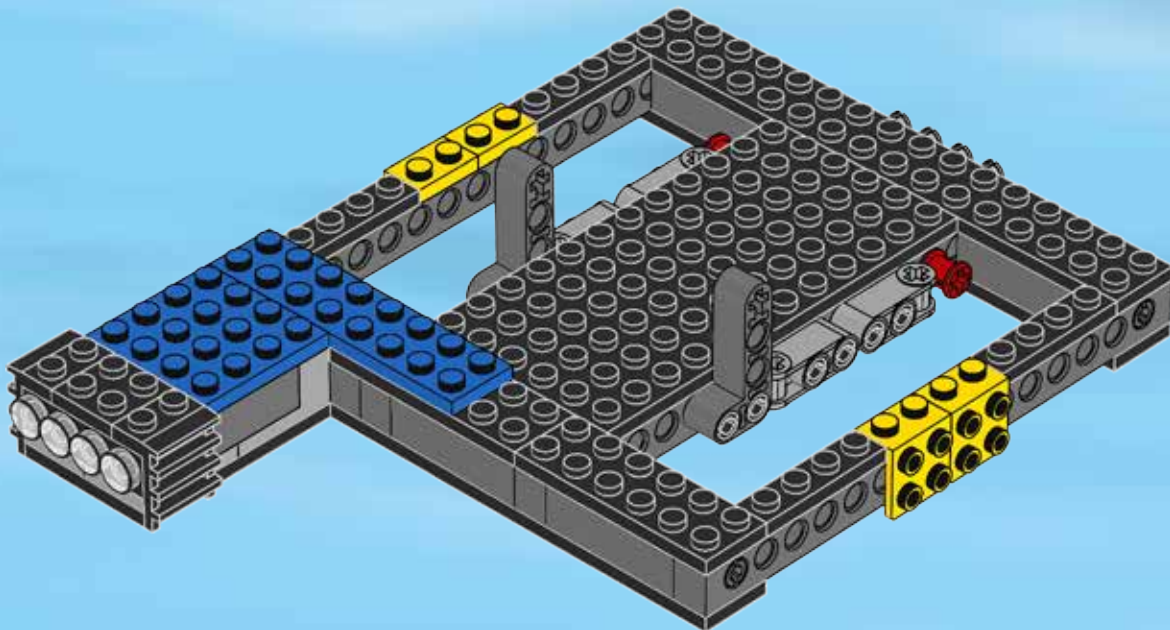



2x

21

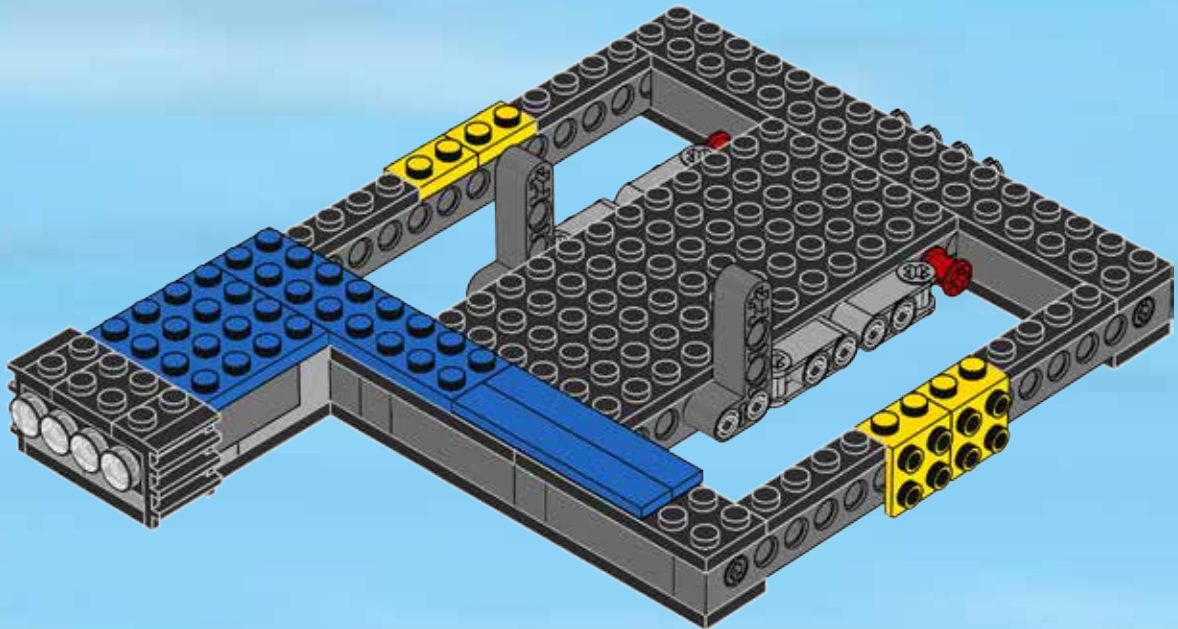



1x



1x

22

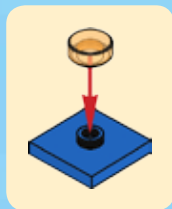
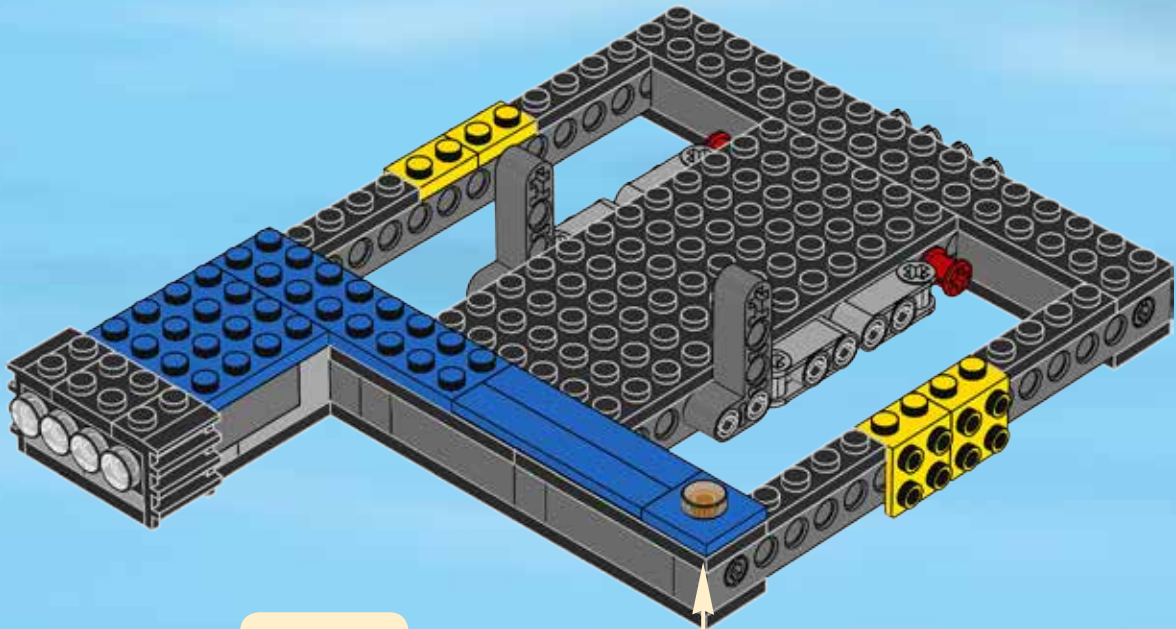



6x

23

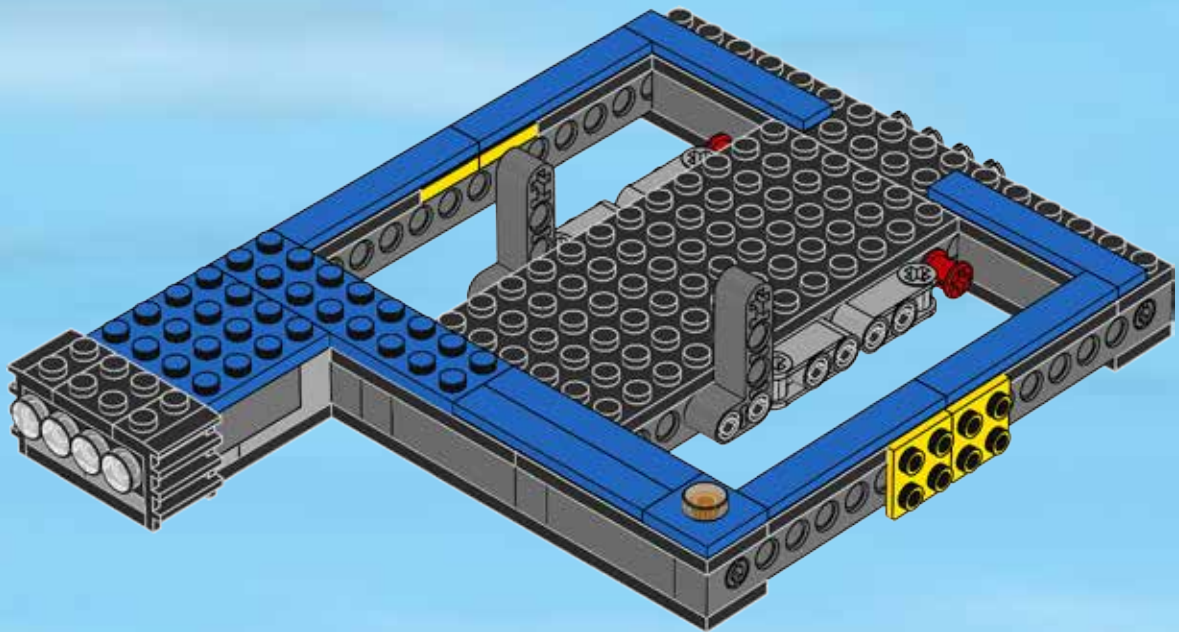



1x



1x

24

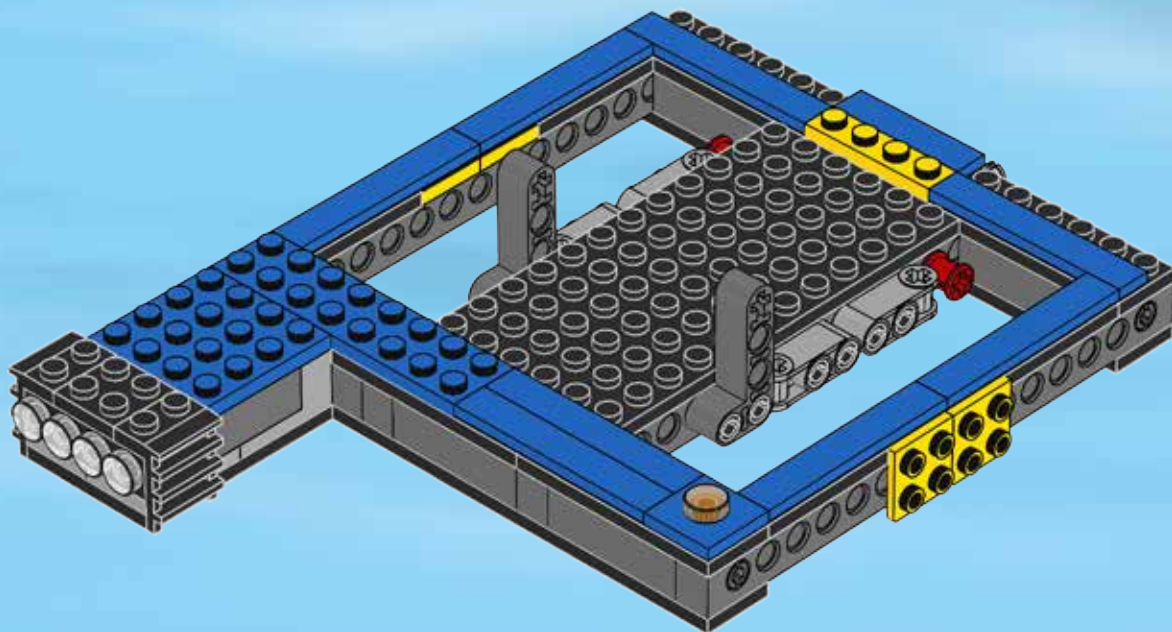

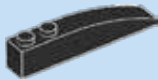

2x

25

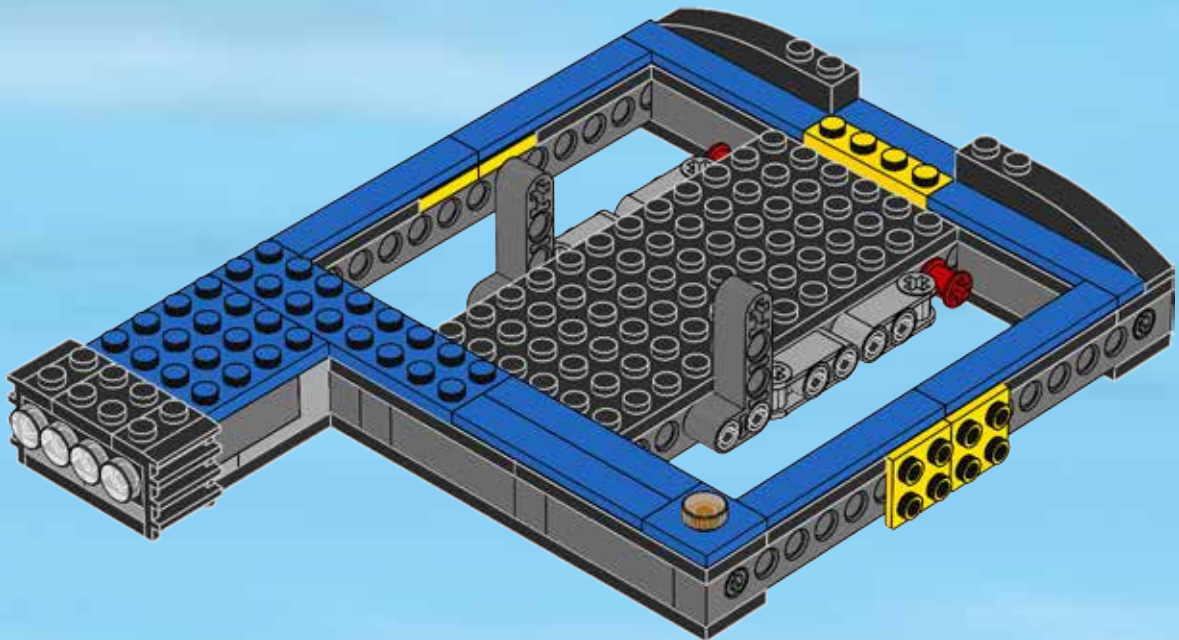



26

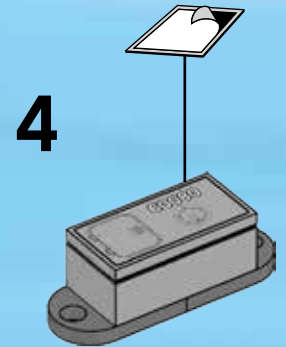
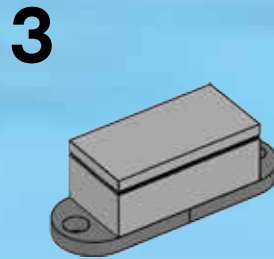
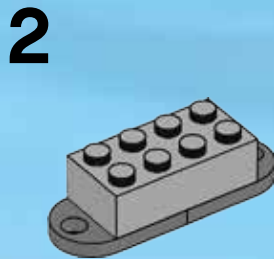
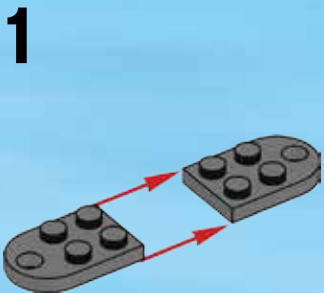

2x

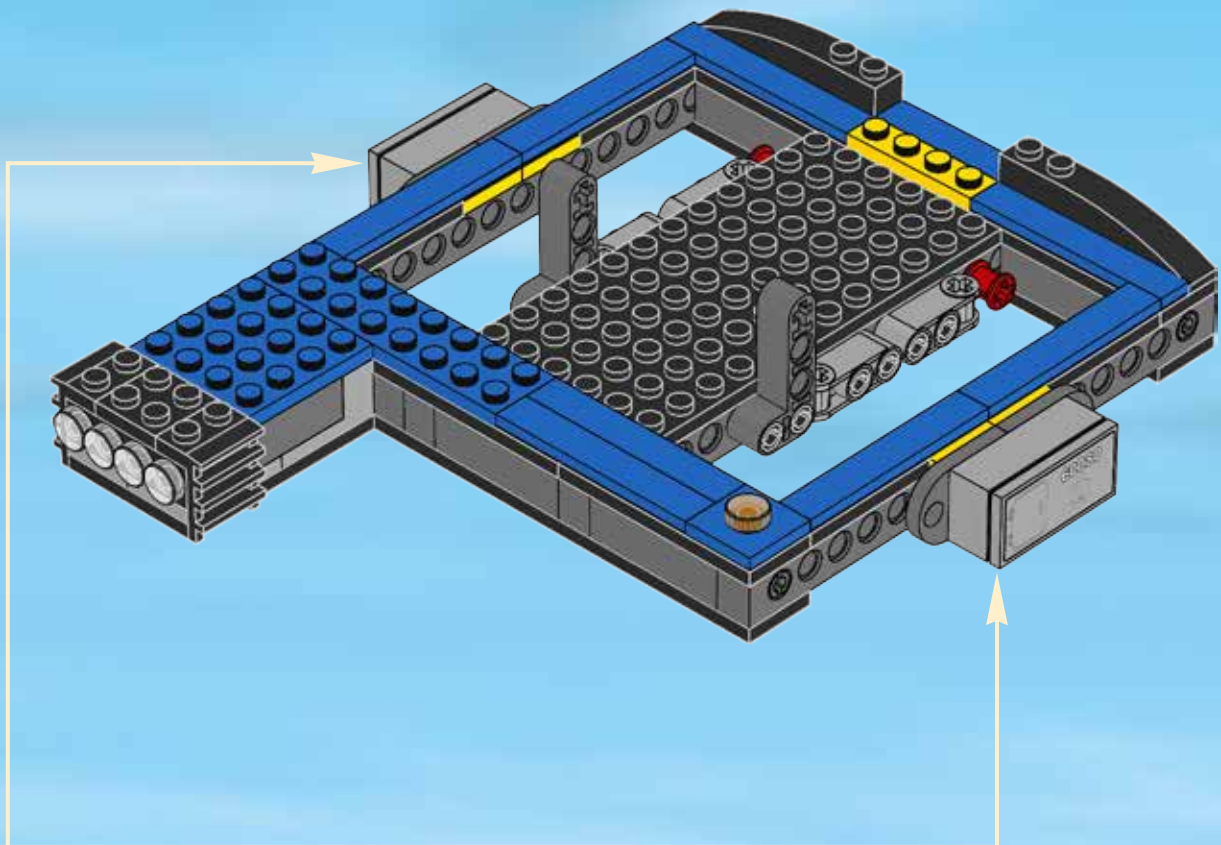

27

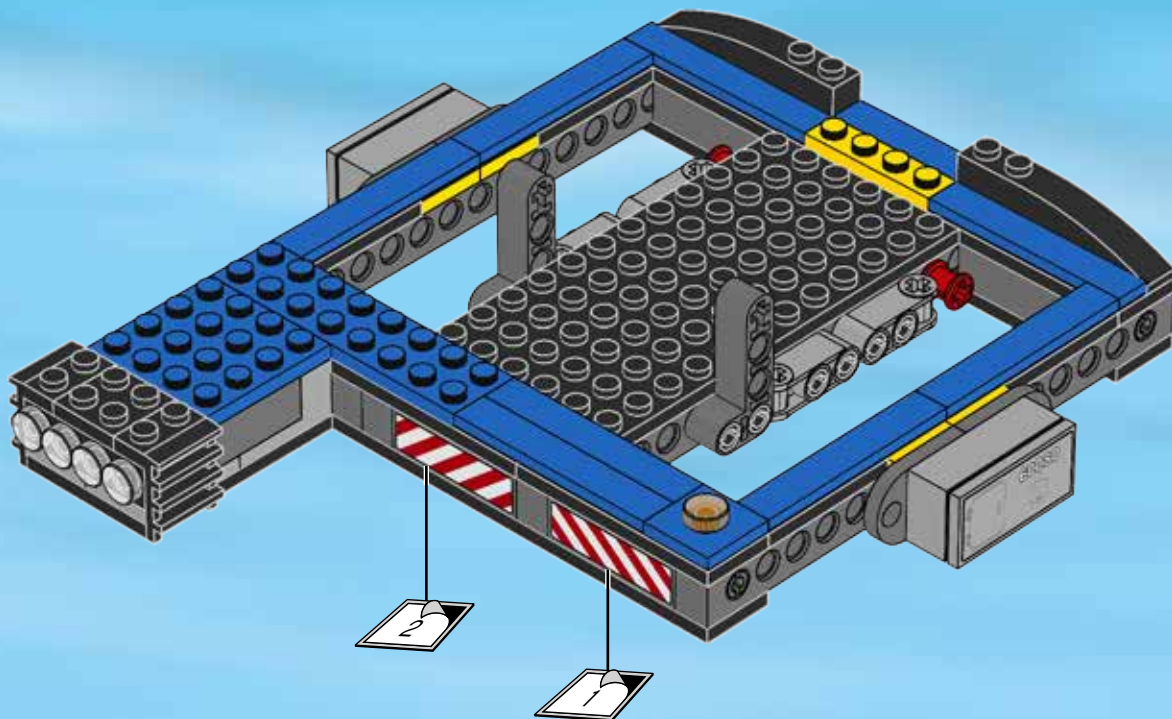

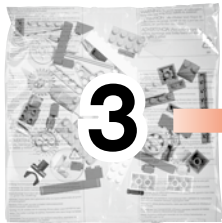



4x

28

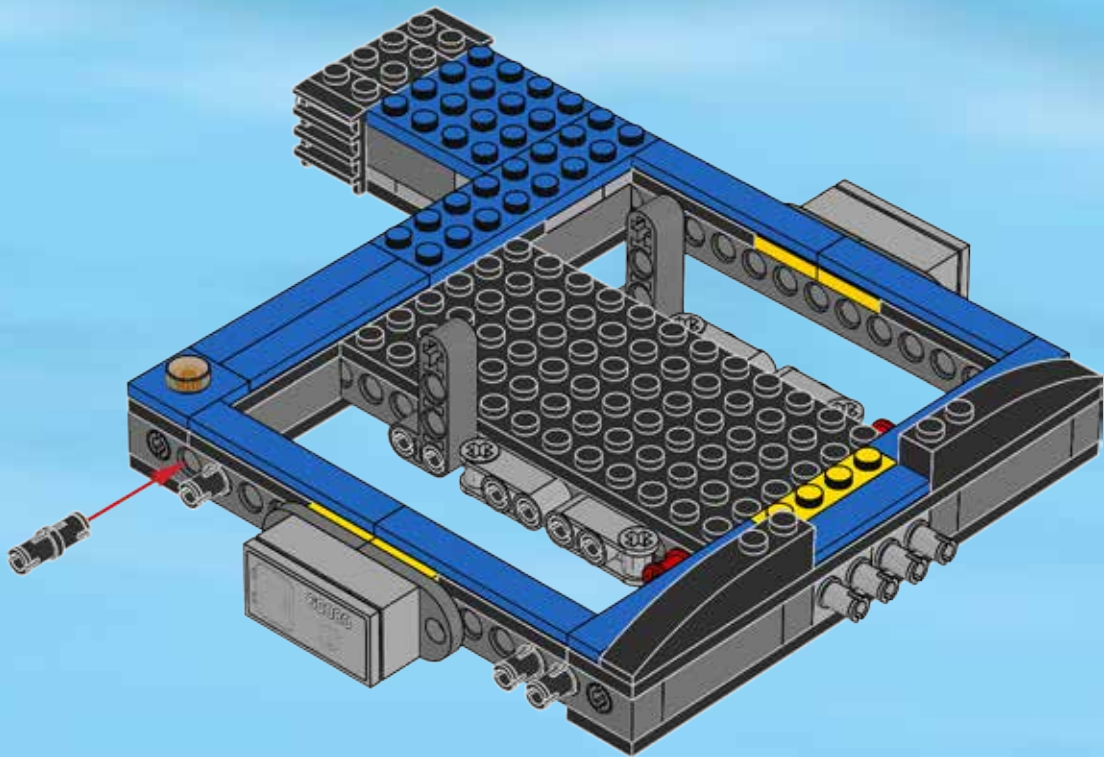



4x

29

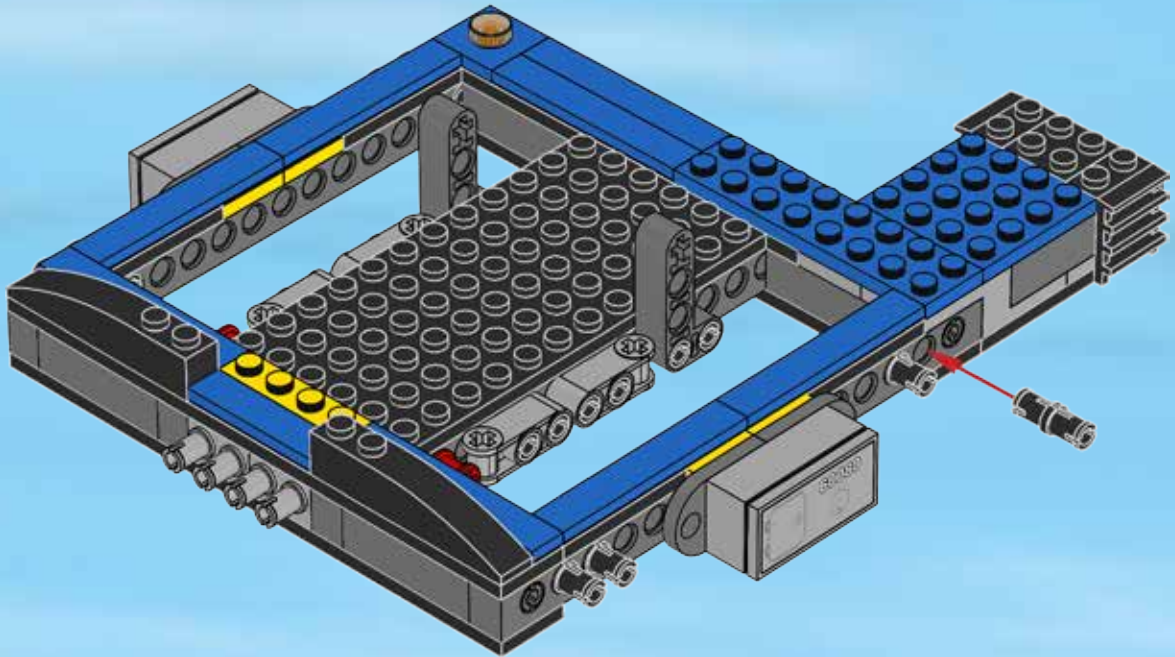



30

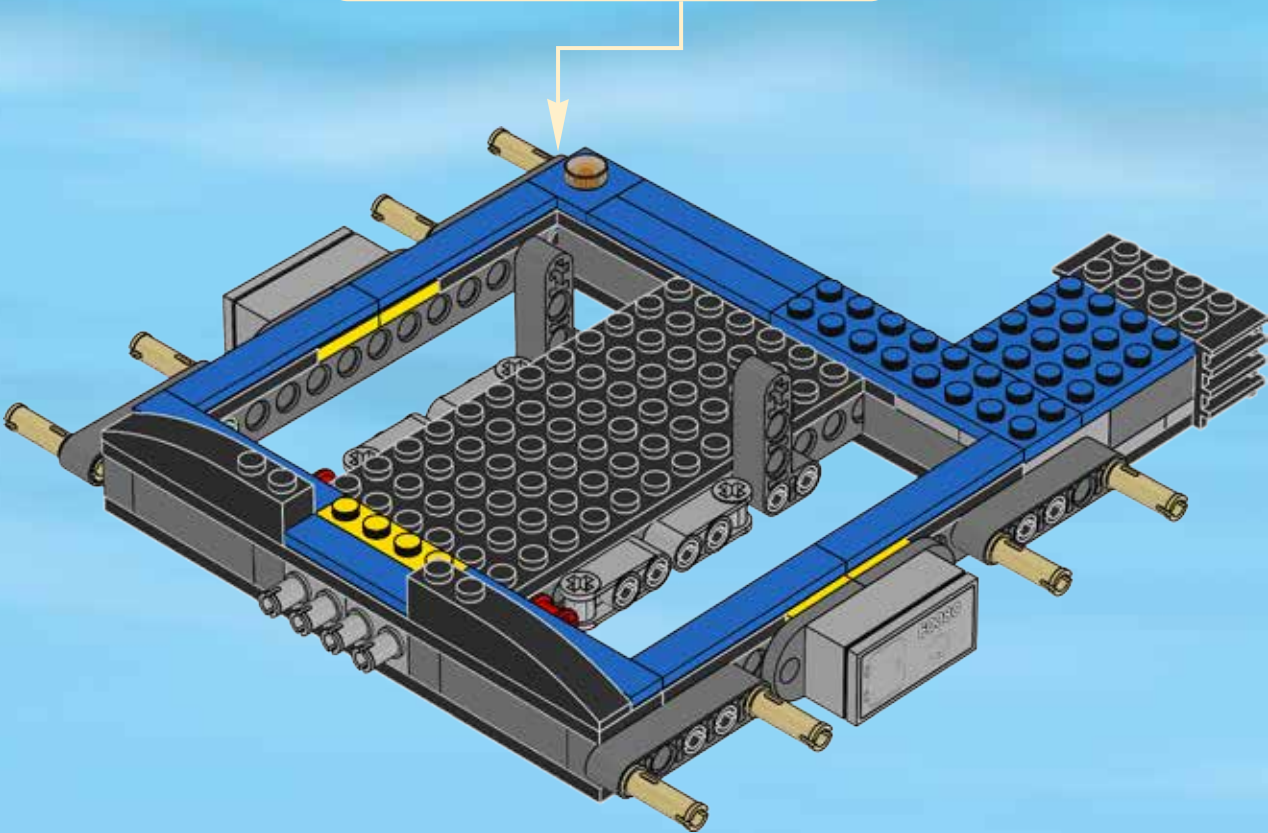
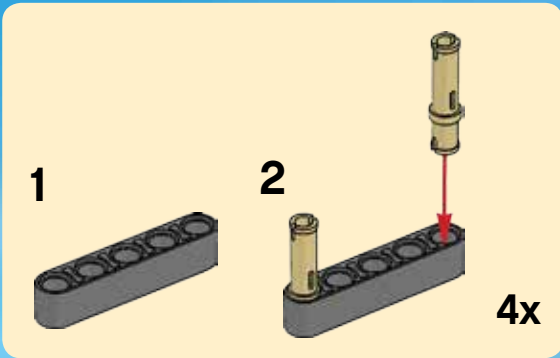



2x

31

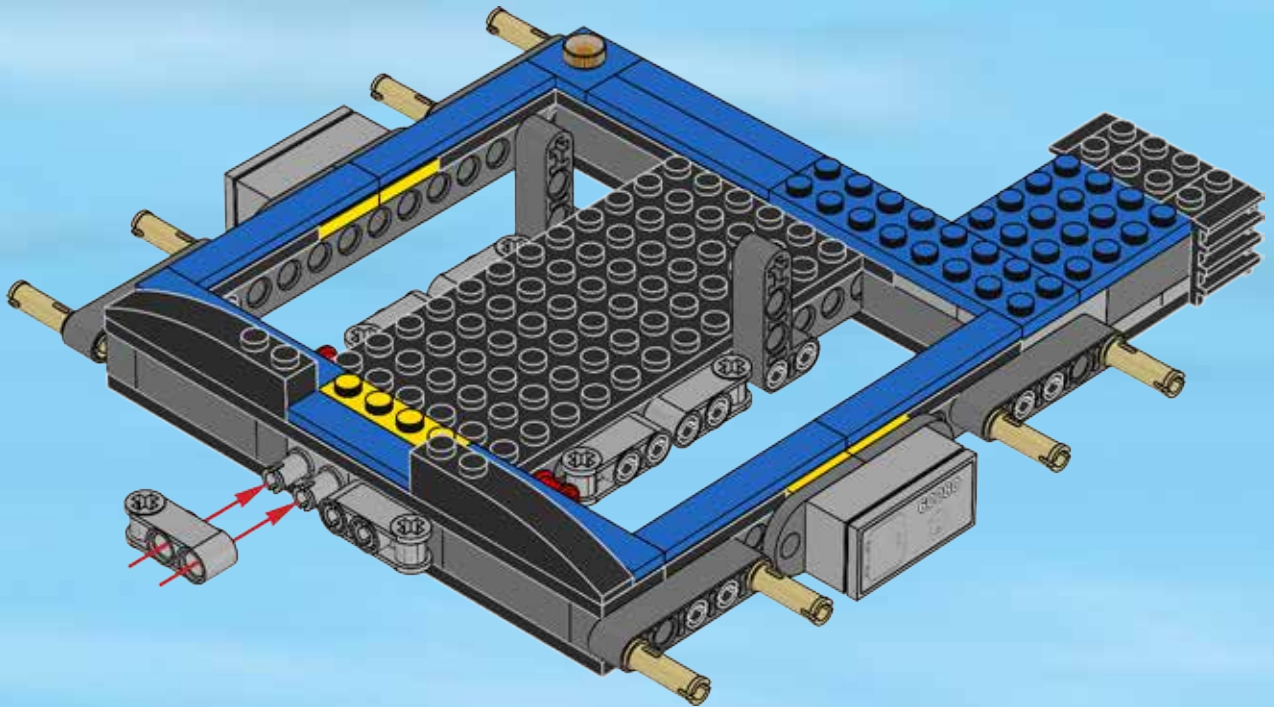



2x

32

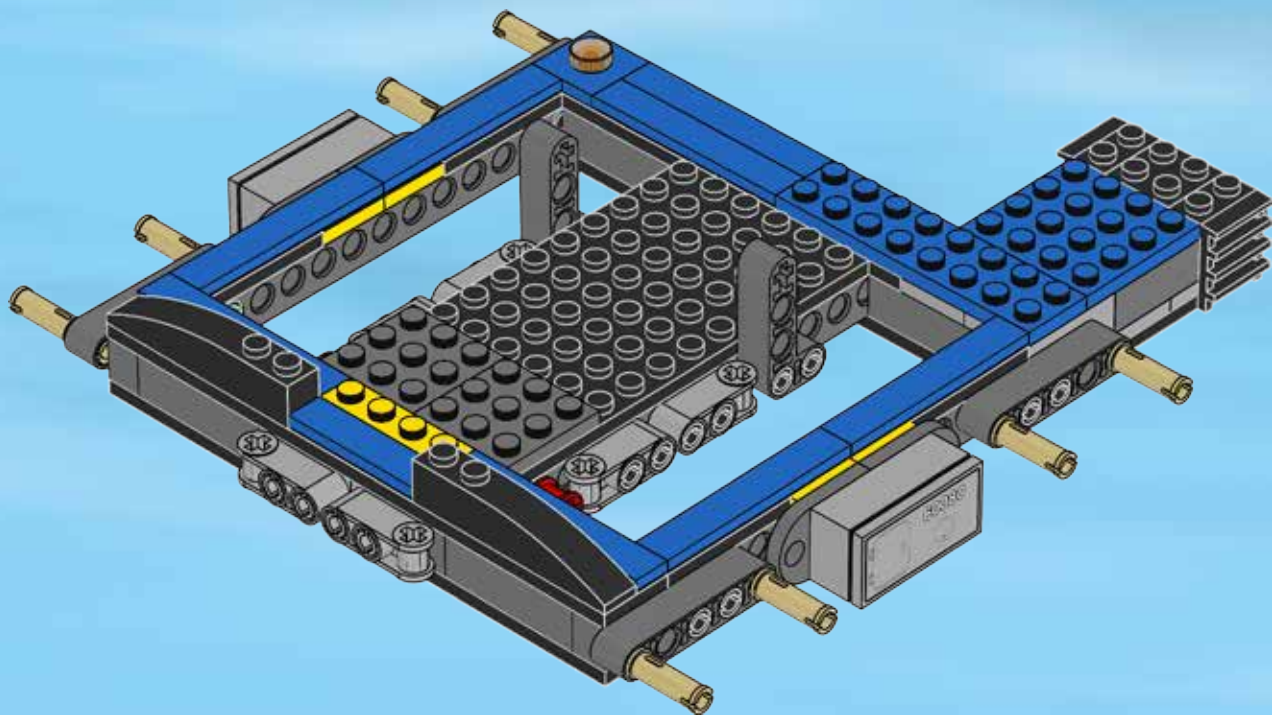

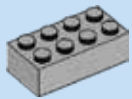

1x



2x

33

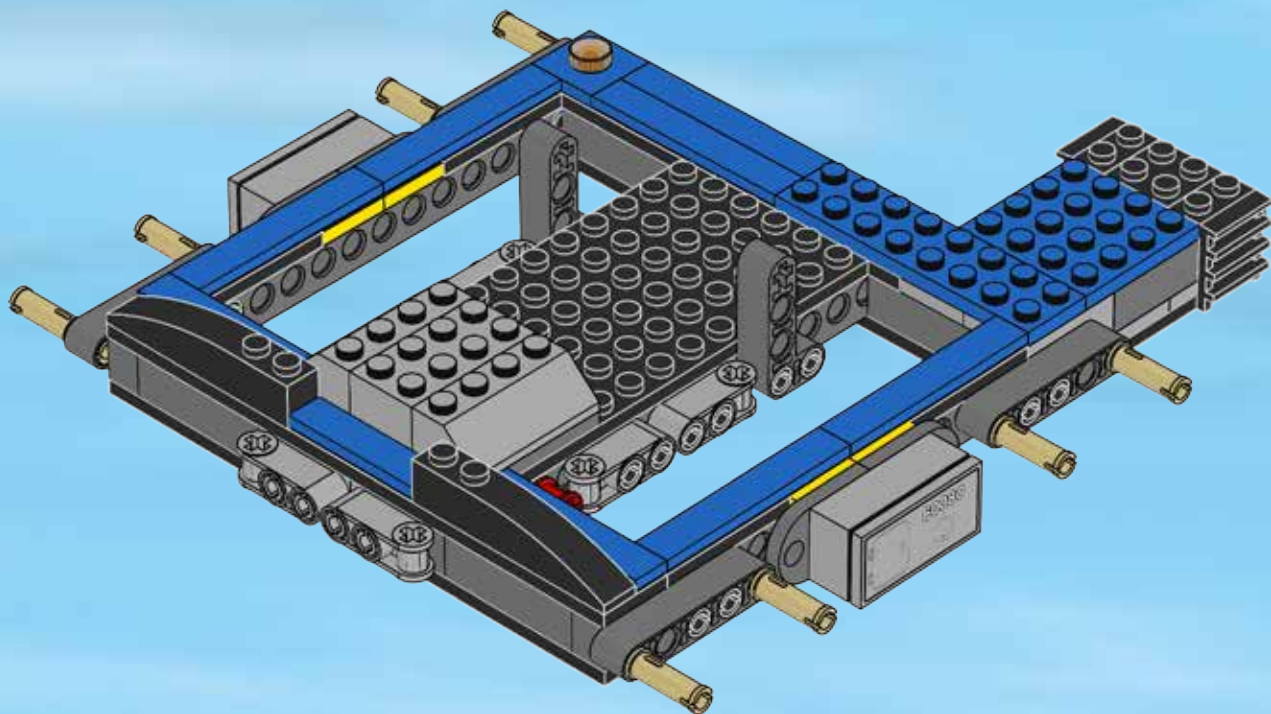

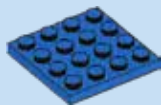

1x

34

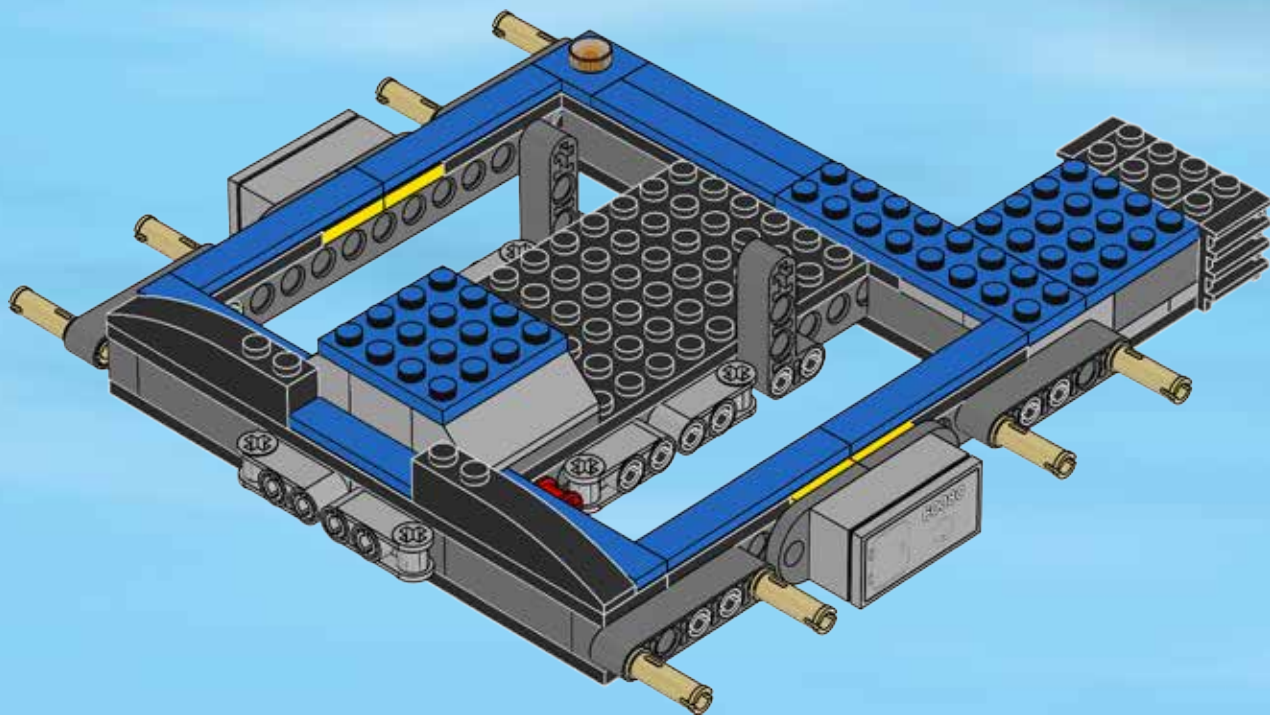

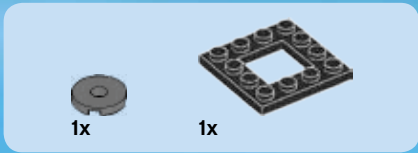

35

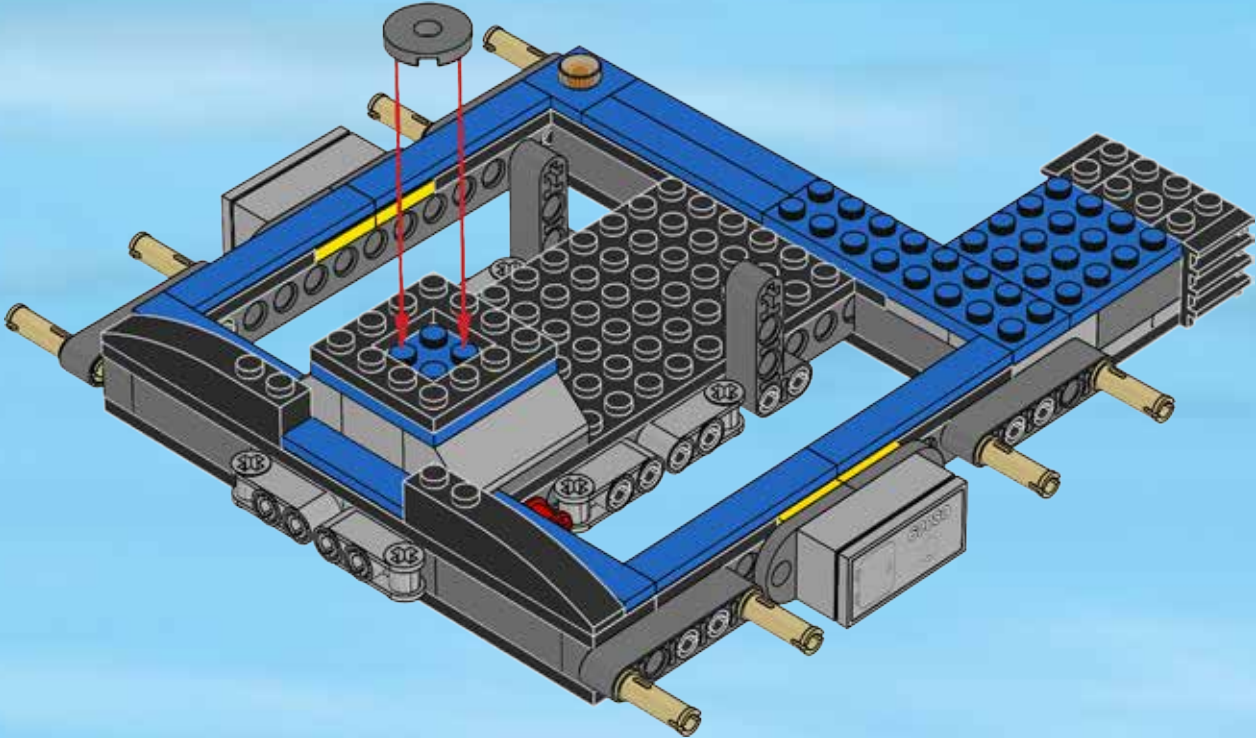

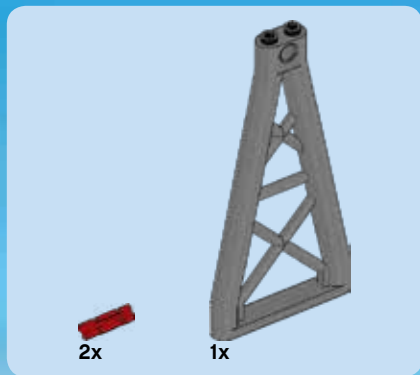

36

1

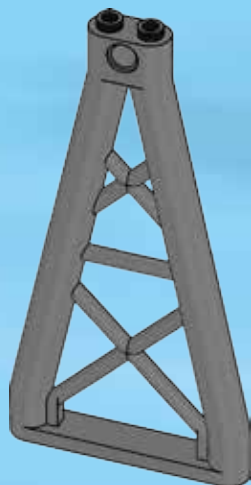

2

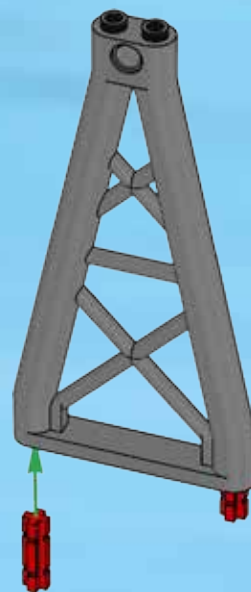

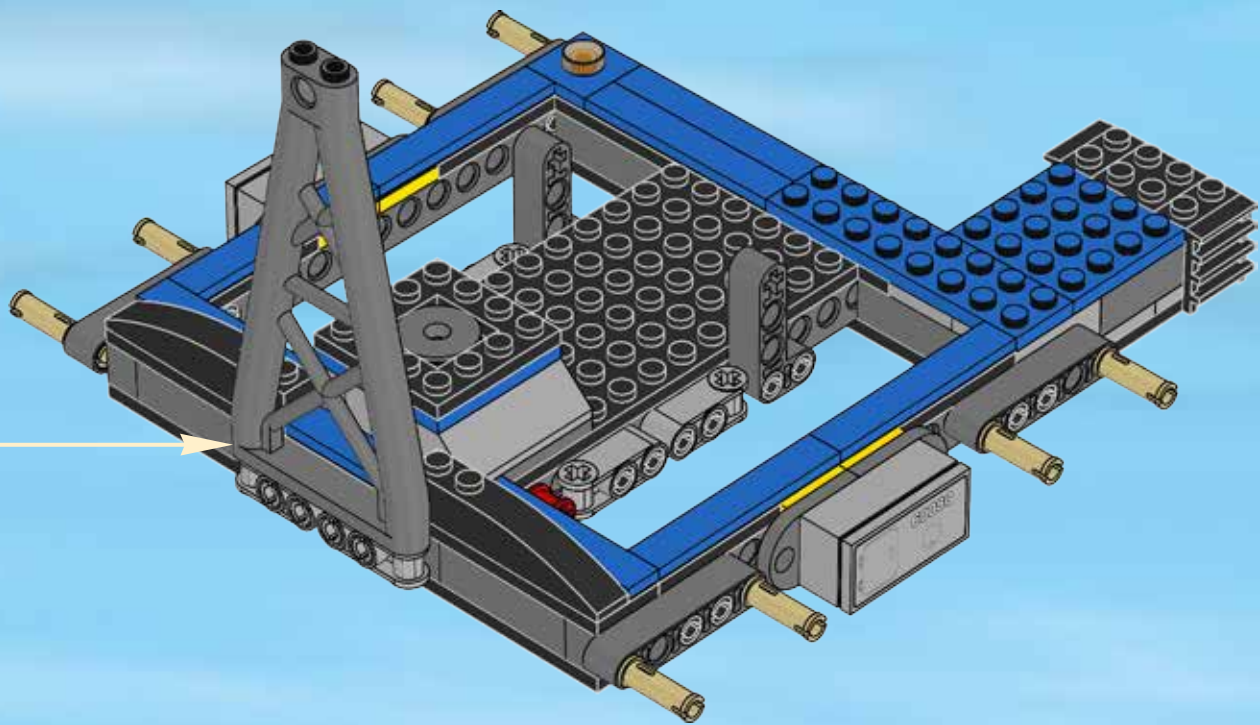

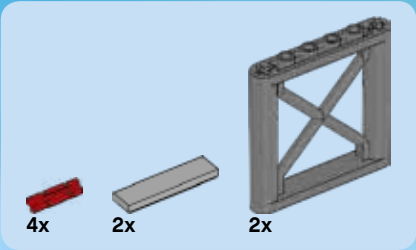

37

1

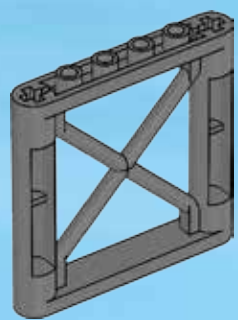

2

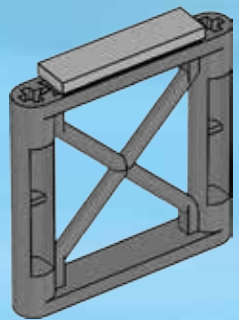

3

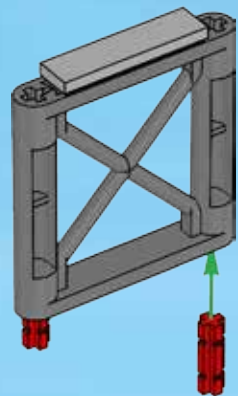

2x

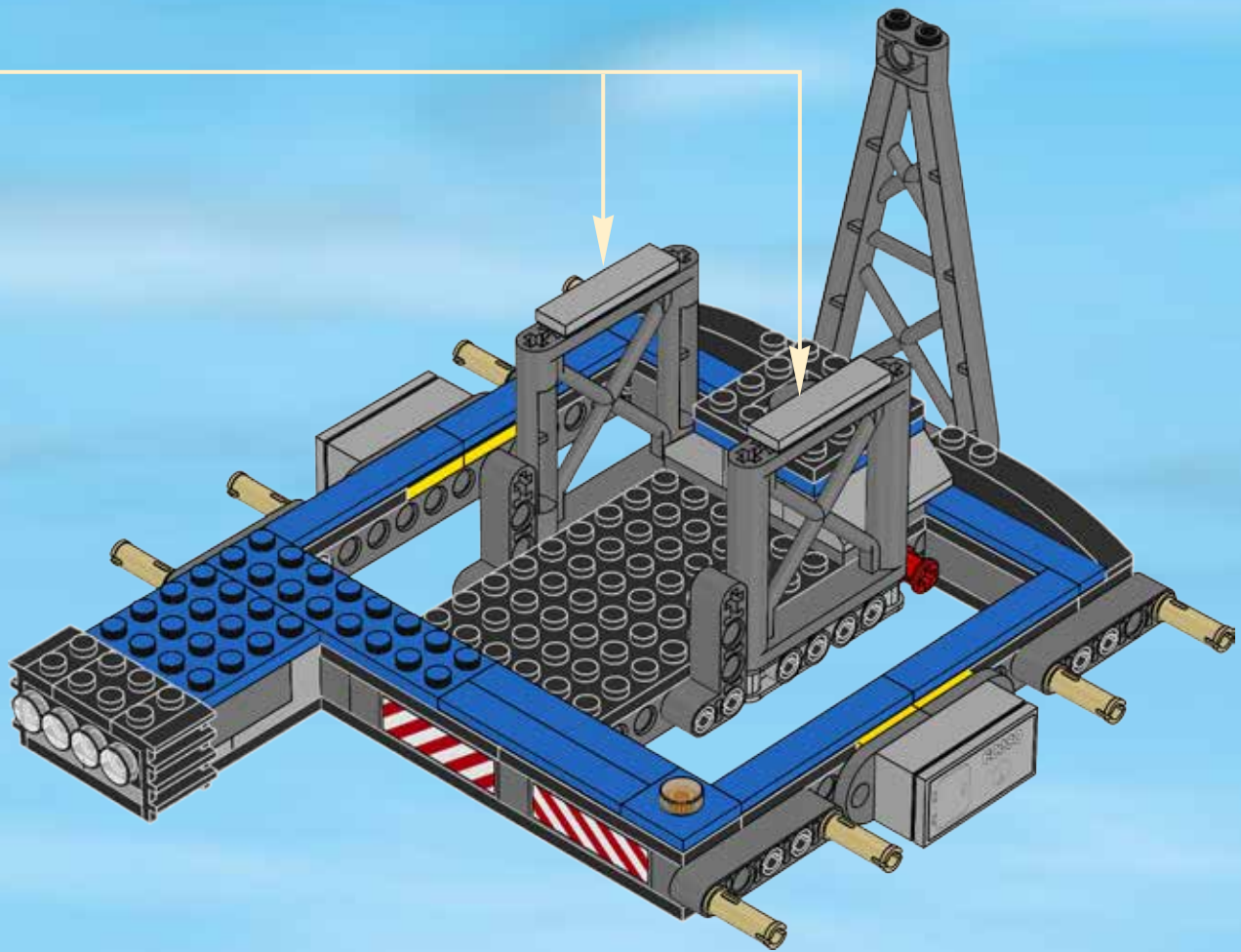



2x



1x

38

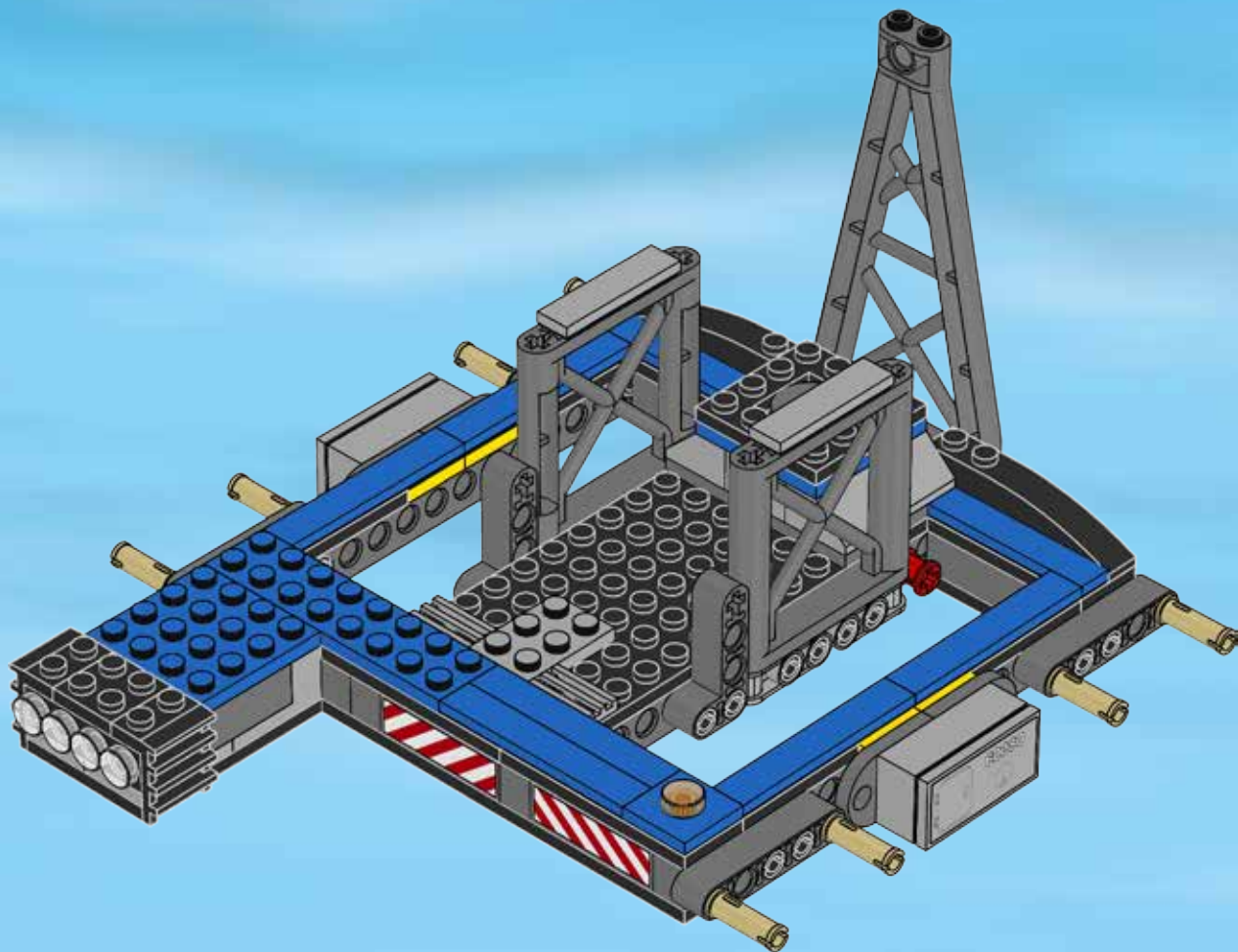



1x

39

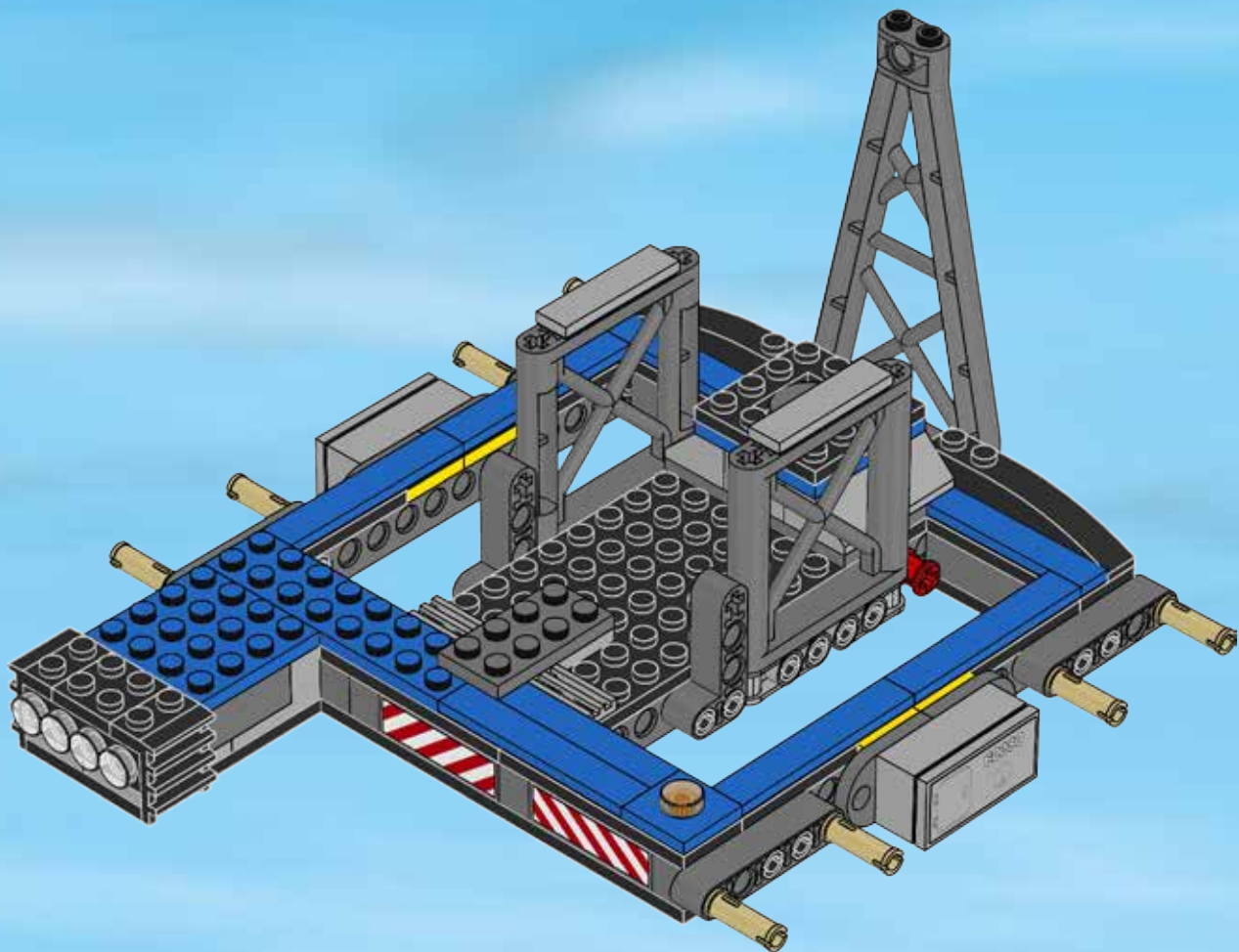



1x

40

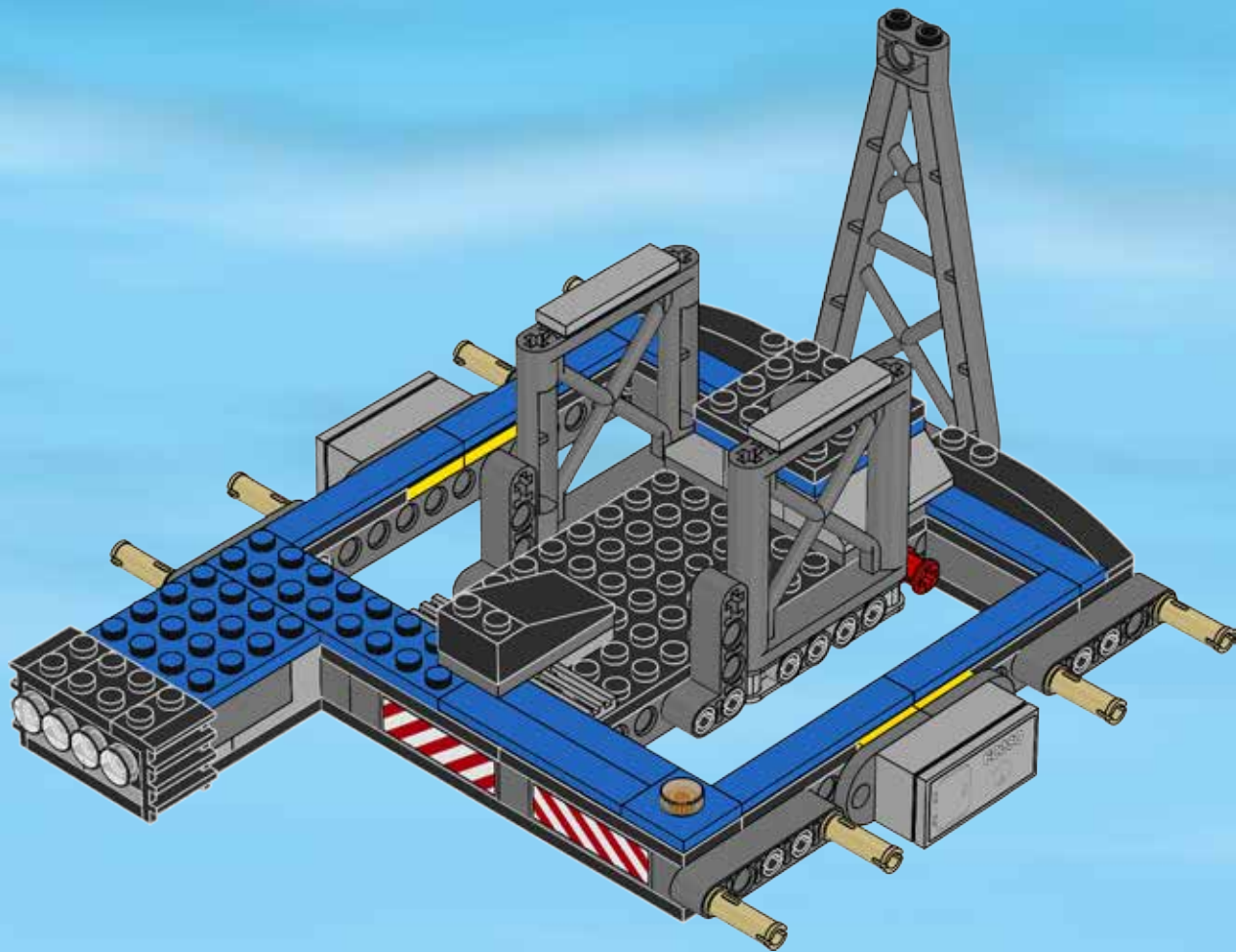



2x

41

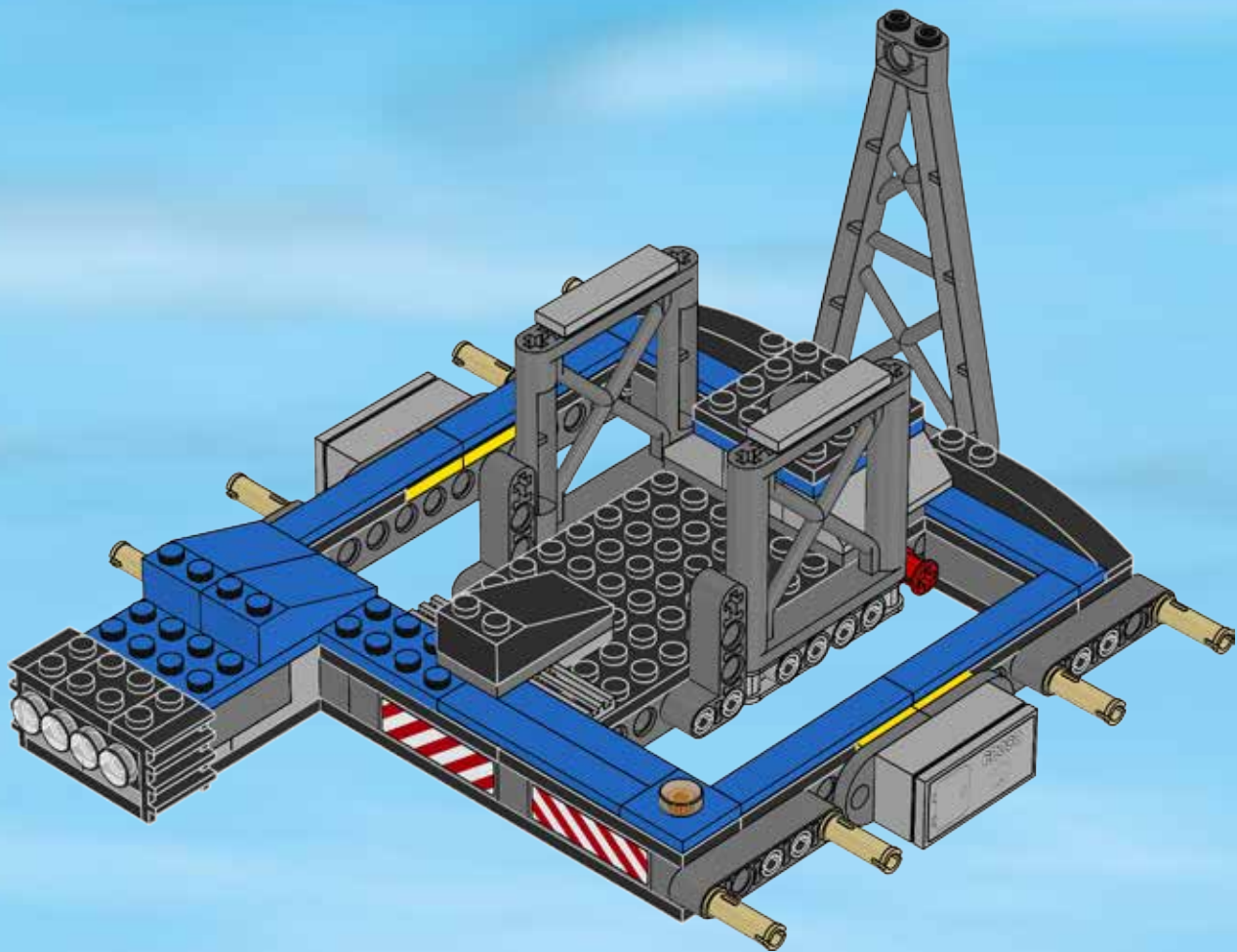



1x



2x

42

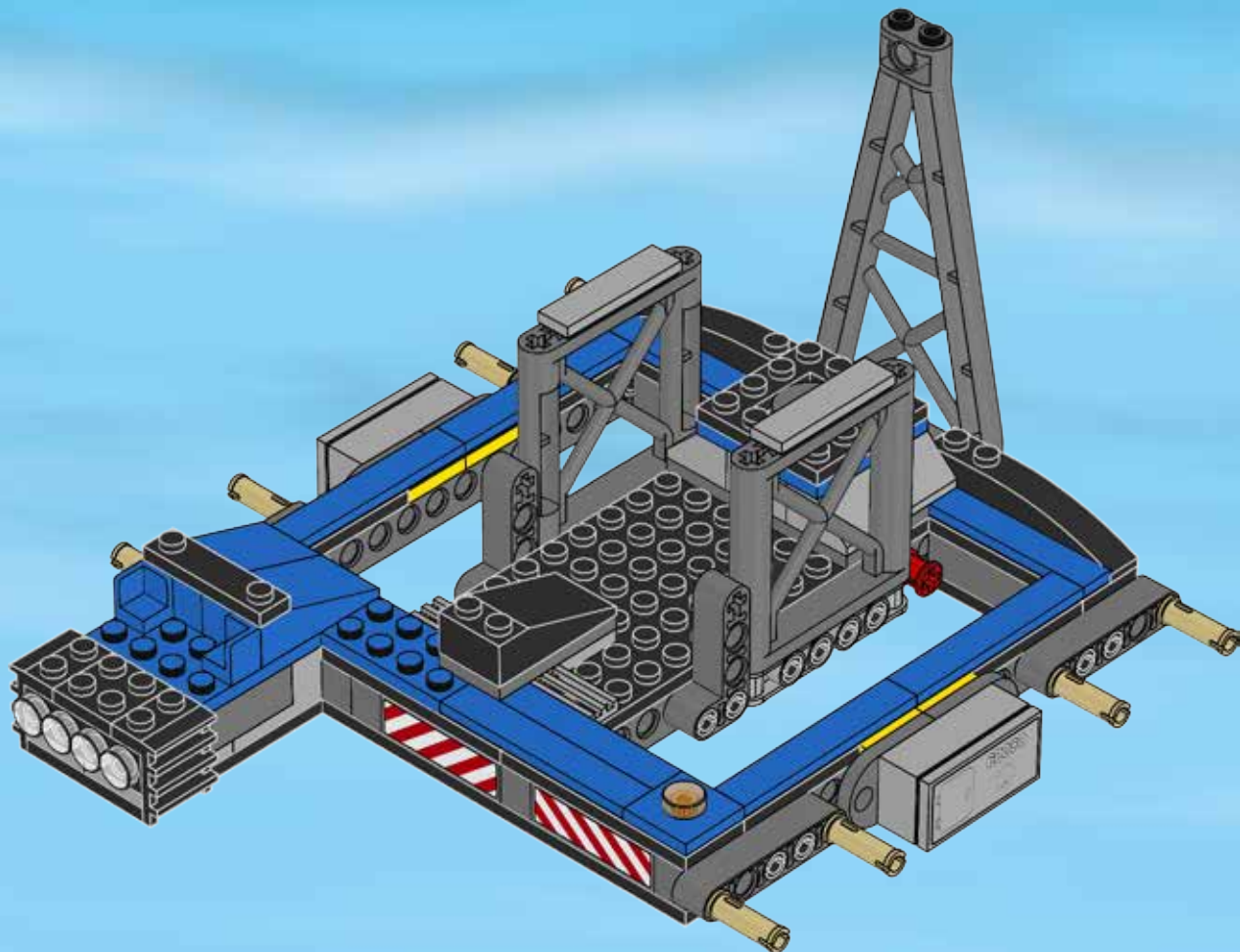



2x

43

1

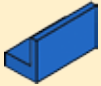

2



2x

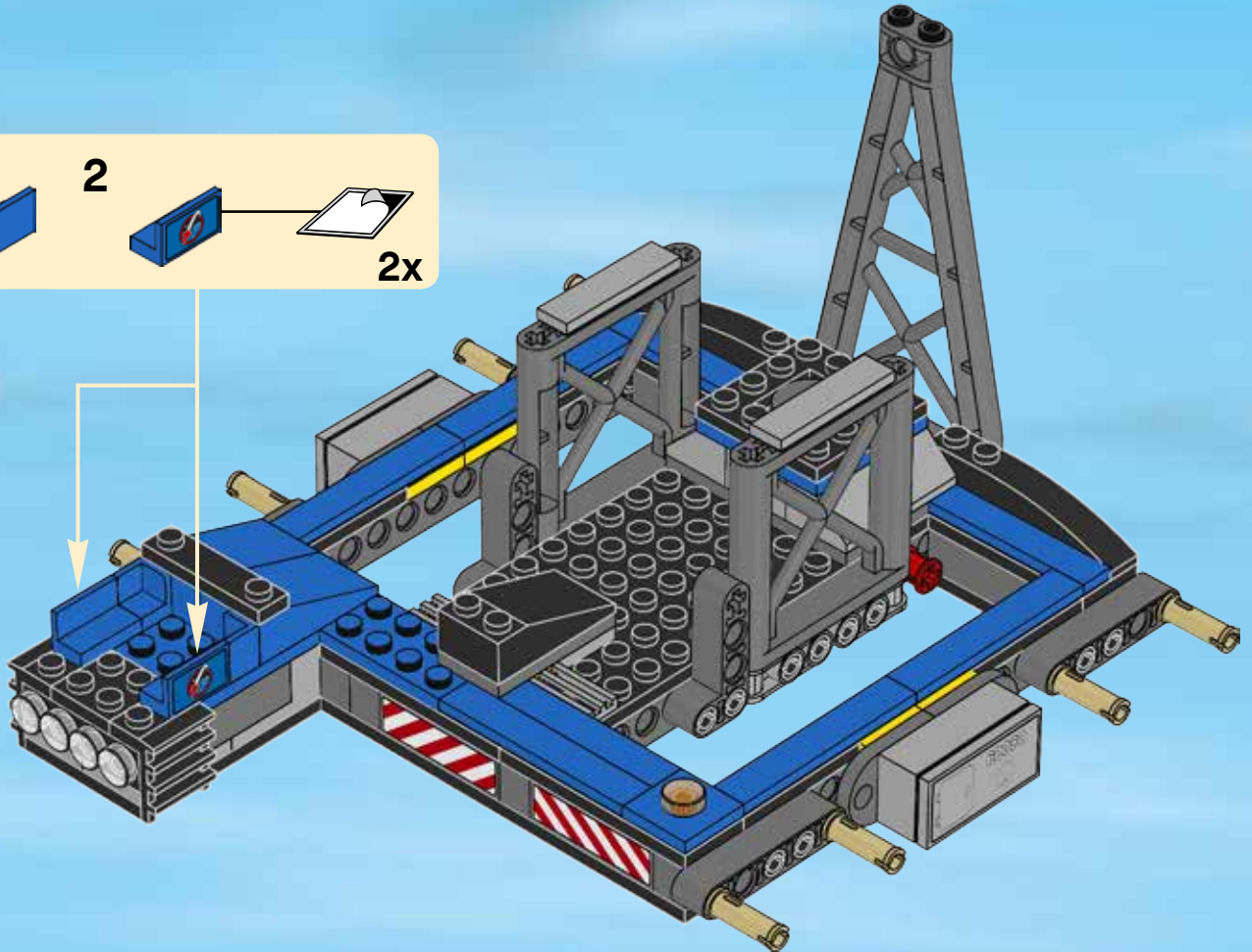



1x



1x

44

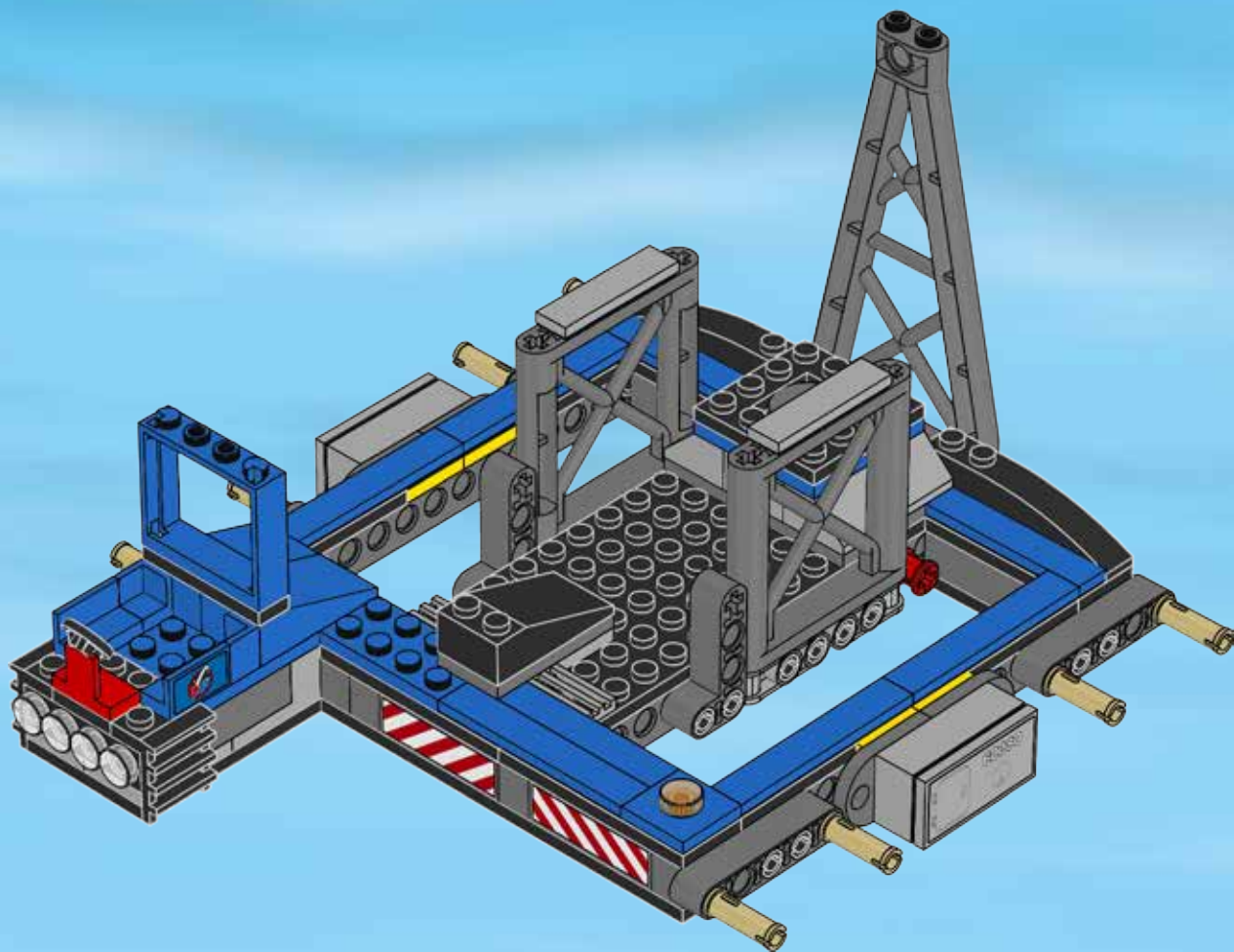

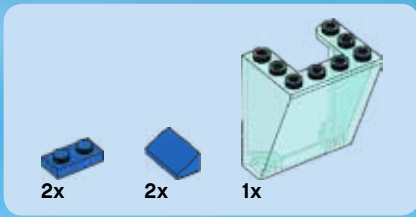

45

1



2

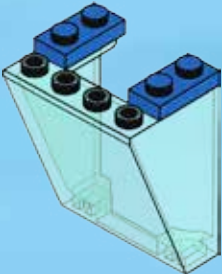

3

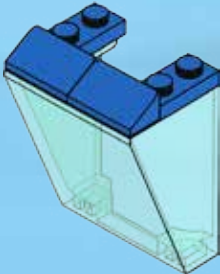





46

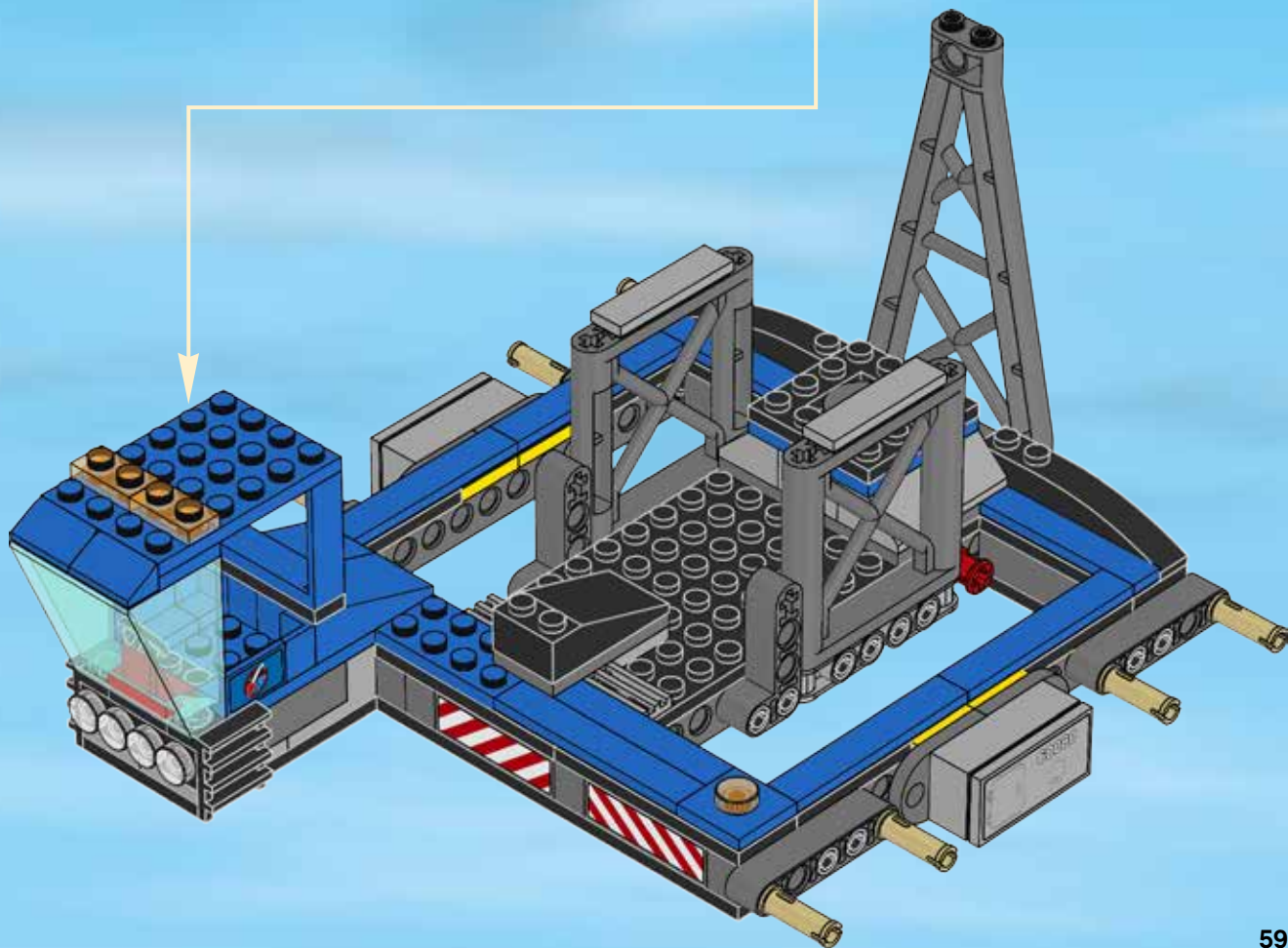
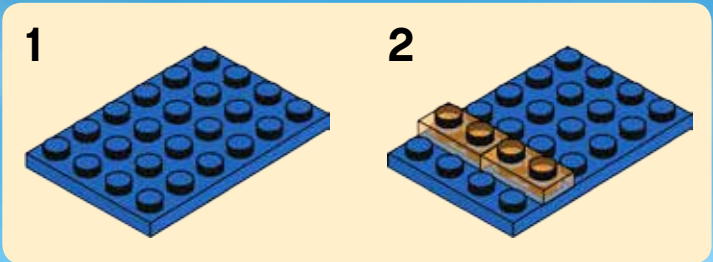



8x



8x

47



8x

